



aerospace  
 climate control  
 electromechanical  
 filtration  
 fluid & gas handling  
 hydraulics  
 pneumatics  
 process control  
 sealing & shielding



# PRODUCT GUIDE



ENGINEERING YOUR SUCCESS.



## Connection Solutions for Industrial Fluids

### Product Guide

This product guide is a representative overview of the Legris low pressure offer. Find out more in Legris' **general catalogue** and on the web site [www.legris.com](http://www.legris.com) or [www.parkerconnectic.com](http://www.parkerconnectic.com).

**Legris**, a division of Parker Hannifin Group, designs, manufactures and markets innovative solutions for connecting, conveying and controlling industrial fluids. Inventor of, and leader in, low pressure instant connection, Legris has based its development and success on essential strategic **customer-focused values**.

### To meet current and future industrial requirements

Legris Connectic works closely with companies that are present in **all industrial fields** and offers a **wide range of products and services** in order to meet the requirements of various sectors: assembly and packaging machines, automation, liquid food circuits, automotive process, etc.

Legris adopts an ongoing strategy of research and product innovation in order to offer a continuous range of **new solutions** and wider applications to its customers.

Legris is certified **ISO 9001 : 2000**.

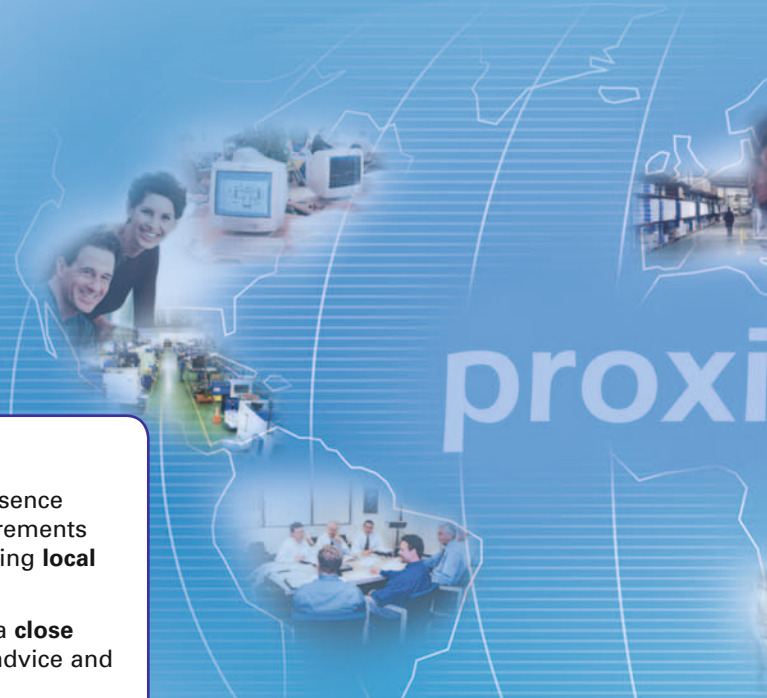

### To be close to you in order to serve you better

Legris Connectic is **present in 76 countries**. This worldwide presence enables Legris to better identify the changes and specific requirements of each market, in order to offer the best solutions, whilst meeting **local standards**.

A genuine sales and technical relay team ensures that there is a **close relationship** with each local market, providing it with support, advice and product logistics.



### European directives ROHS, ELV, WEEE and REACH

Legris has always encouraged the use of non dangerous substances (heavy metals, bromine derivatives) in the design of its products in order to protect the **environment** and to safeguard **public health**. Thus, every effort has been made to ensure that **concerned ranges** would respect European directives **RoHS** (Reduction of Hazardous Substances - 2002/95/CE), **ELV** (End of Vehicle Life - 2000/53/CE), **WEEE** (Waste Electrical and Electronic Equipment- 2002/96/CE), by 1st July 2006 and **REACH** (Registration Evaluation Authorization Chemicals - RG 1907/2006).

### Additional information accessible to everyone via the Legris website

[www.legris.com](http://www.legris.com) includes the complete range of European, Asian and American products and gives **access** to thousands of product part numbers. Three search facilities direct the user to a complete and **real-time, updated** product file with technical drawings and pictures.

Each catalogue offers the possibility to place and receive **quotation requests**, which will be sent to distributors within the same corresponding geographical area.

Sections containing technical advice and animated graphics offer the user an **optimized understanding** of product technologies and their applications.



### Saving on design time with downloadable CAD drawings

Legris Connectic offers the possibility to download CAD drawings for a large number of products. This service is available to all, via [legris.com](http://legris.com), through a **free, quick and easy** download and the formats provided (2D and 3D) are compatible with the main CAD systems used worldwide.

This enables time-saving in equipment design: each downloaded component can be directly integrated into an assembly, with the associated nomenclature. In addition, this service **guarantees** choice. Indeed, with Legris CAD drawings you can ensure that the selected components are suitable for use with other components within the assembly.



# Build your installation with the Legris range

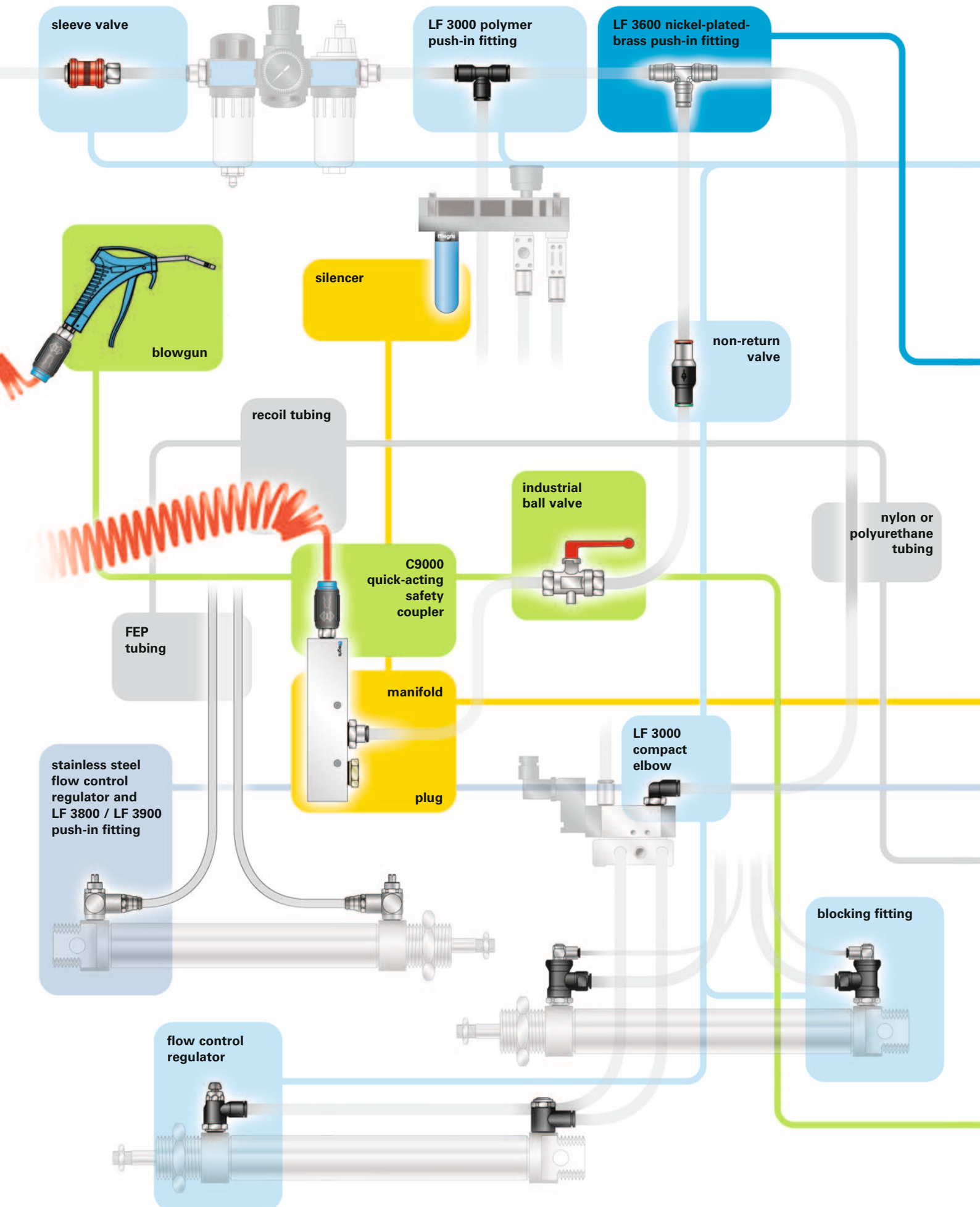

# Contents of this Product Guide



## Pneumatic Applications

LF 3000 polymer push-in fittings, flow control regulators, pneumatic function fittings and universal compression fittings  
pages 6 to 15

## For Demanding Applications

LF 3600 chemical nickel-plated brass instant fittings, function fittings and accessories  
pages 16 to 17



## For Aggressive Fluids and Environments

Stainless steel fittings : LF 3900 / LF 3800 instant fittings, flow control regulators and accessories  
pages 20 to 22



## Accessories and Plugs

pages 18 to 19

## Technical Tubes

pages 23 to 25



## Complementary Range

Complementary range : C9000 quick-acting couplers, blowguns and ball valves  
pages 26 to 28



This product guide is a representative overview of the Legris low pressure offer. Find out more in Legris **general catalogue** and on the web site [www.legris.com](http://www.legris.com) or [www.parkerconnectic.com](http://www.parkerconnectic.com)

# LF 3000 Polymer Instant Fittings

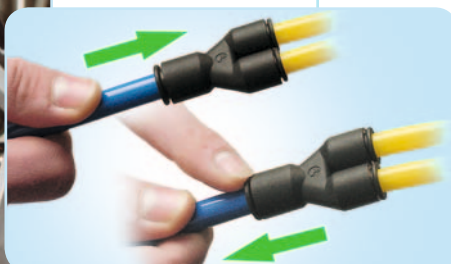
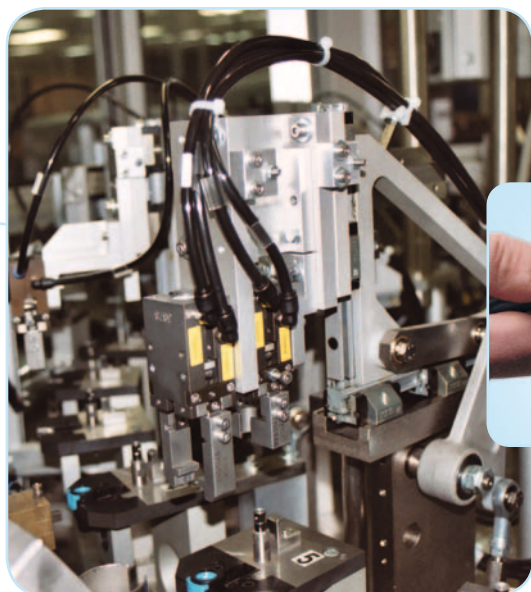

## Applications

- used to connect **pneumatic devices** in **many industrial applications** : assembly machines, packaging equipment, factory automation, automotive process industry, textile machinery, printing machinery, vacuum networks ...etc  
The LF 3000 range meets the latest international **standard ISO 14743**, for push-in connectors used in conjunction with thermoplastic tubes.

## Benefits

- **time saving** and **simplicity** of installation : instant connection and disconnection without the use of tools

- **full flow** as gripping and sealing are achieved using the outside of the tube.
- **immediate sealing** : reinforced sealing by a captive 'O' ring seal for parallel threaded fittings and PTFE coating for taper threaded fittings.
- **compactness and aesthetic**: optimised dimensions and internal hexagons on straight fittings.
- **orientable** body for positioning purposes
- **multiple configurations**: a solution for all tubing configurations



### ■ a solution for all applications

- wide variety of body designs and numerous configurations from 3 to 14 mm diameters.
- 3 types of thread : BSP parallel (BSPP), BSP taper (BSPT) and metric.

**Special versions available on request – Please consult us.**

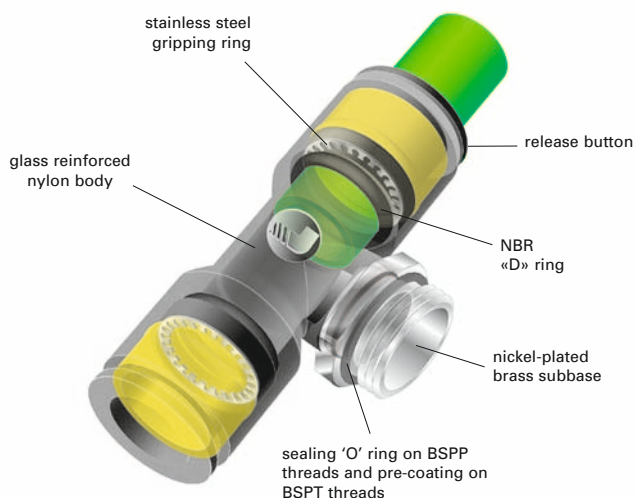

## Technical specifications

### suitable fluids :

compressed air

*LF 3000® can also be used for conveying various types of liquids (water, cutting oil, etc) for industrial applications. The working pressure, from 0 to 6/10 bar, and temperatures, from 0 to 60°C, are dependent upon the fluid conveyed and the type of 'O' ring used. For further information, please consult us.*

**working pressure :**  
20 bar maximum

**vacuum capability :**  
vacuum of 755 mm Hg (99% vacuum)

**working temperature :**  
- 20° to + 80°C

All items in the LF 3000 range are guaranteed **silicone free**.

### maximum tightening torque for LF 3000® fittings, BSPP and metric threads

Thread	M3 x 0,5	M5 x0,8	M7 x1	G1/8"	G1/4"	G3/8"	G1/2"
da N.m	0,06	0,16	0,8	0,8	1,2	3	3,5

# Threaded Fittings

Designed to satisfy your requirements

## 3109



- compactness for better space utilisation
- the body is **orientable** for positioning purposes
- allowing overlap assembly with extended elbow (models 3129 and 3169)
- available from **3 mm** to **14 mm** diameters

male stud fitting, hexagonal, BSPT thread

## 3175



ØD	C	
4	R1/8	3175 04 10
4	R1/4	3175 04 13
6	R1/8	3175 06 10
6	R1/4	3175 06 13
6	R3/8	3175 06 17
6	R1/2	3175 06 21
8	R1/8	3175 08 10
8	R1/4	3175 08 13
8	R3/8	3175 08 17
10	R1/4	3175 10 13
10	R3/8	3175 10 17
10	R1/2	3175 10 21
12	R3/8	3175 12 17
12	R1/2	3175 12 21
14	R3/8	3175 14 17
14	R1/2	3175 14 21

male stud fitting, hexagonal, BSPP and metric thread

## 3101



ØD	C	
4	M5x0,8	3101 04 19
4	G1/8	3101 04 10
4	G1/4	3101 04 13
6	M5x0,8	3101 06 19
6	G1/8	3101 06 10
6	G1/4	3101 06 13
6	G3/8	3101 06 17
8	G1/8	3101 08 10
8	G1/4	3101 08 13
8	G3/8	3101 08 17
10	G1/4	3101 10 13
10	G3/8	3101 10 17
10	G1/2	3101 10 21
12	G3/8	3101 12 17
12	G1/2	3101 12 21
14	G3/8	3101 14 17
14	G1/2	3101 14 21

male stud elbow, BSPT thread

## 3109



ØD	C	
4	R1/8	3109 04 10
4	R1/4	3109 04 13
4	R3/8	3109 04 17
6	R1/8	3109 06 10
6	R1/4	3109 06 13
6	R3/8	3109 06 17
8	R1/8	3109 08 10
8	R1/4	3109 08 13
8	R3/8	3109 08 17
10	R1/4	3109 10 13
10	R3/8	3109 10 17
10	R1/2	3109 10 21
12	R3/8	3109 12 17
12	R1/2	3109 12 21
14	R3/8	3109 14 17
14	R1/2	3109 14 21

extended male stud elbow, BSPT thread

## 3129



ØD	C	
4	R1/8	3129 04 10
4	R1/4	3129 04 13
6	R1/8	3129 06 10
6	R1/4	3129 06 13
8	R1/8	3129 08 10
8	R1/4	3129 08 13
8	R3/8	3129 08 17
10	R1/4	3129 10 13
10	R3/8	3129 10 17
10	R1/2	3129 10 21

male stud elbow, BSPP and metric thread

## 3199



ØD	C	
4	M5x0,8	3199 04 19
4	G1/8	3199 04 10
4	G1/4	3199 04 13
6	M5x0,8	3199 06 19
6	G1/8	3199 06 10
6	G1/4	3199 06 13
6	G3/8	3199 06 17
8	G1/8	3199 08 10
8	G1/4	3199 08 13
8	G3/8	3199 08 17
10	G1/4	3199 10 13
10	G3/8	3199 10 17
10	G1/2	3199 10 21
12	G3/8	3199 12 17
12	G1/2	3199 12 21
14	G3/8	3199 14 17
14	G1/2	3199 14 21

extended male stud elbow, BSPP and metric thread

## 3169



ØD	C	
4	M5x0,8	3169 04 19
4	G1/8	3169 04 10
6	M5x0,8	3169 06 19
6	G1/8	3169 06 10
6	G1/4	3169 06 13
8	G1/8	3169 08 10
8	G1/4	3169 08 13
8	G3/8	3169 08 17
10	G1/4	3169 10 13
10	G3/8	3169 10 17
10	G1/2	3169 10 21

45° male elbow, BSPT thread

## 3113



ØD	C	
4	R1/8	3113 04 10
6	R1/8	3113 06 10
6	R1/4	3113 06 13
8	R1/8	3113 08 10
8	R1/4	3113 08 13
8	R3/8	3113 08 17
10	R1/4	3113 10 13
10	R3/8	3113 10 17
10	R1/2	3113 10 21

45° male elbow, BSPP and metric thread

## 3133



ØD	C	
4	M5x0,8	3133 04 19
4	G1/8	3133 04 10
6	M5x0,8	3133 06 19
6	G1/8	3133 06 10
6	G1/4	3133 06 13
8	G1/8	3133 08 10
8	G1/4	3133 08 13
8	G3/8	3133 08 17
10	G1/4	3133 10 13
10	G3/8	3133 10 17
10	G1/2	3133 10 21

female stud fitting, BSPP and metric thread

## 3114



ØD	C	
4	M5x0,8	3114 04 19
4	G1/8	3114 04 10
4	G1/4	3114 04 13
6	G1/8	3114 06 10
6	G1/4	3114 06 13
8	G1/8	3114 08 10
8	G1/4	3114 08 13
10	G1/4	3114 10 13
10	G3/8	3114 10 17
10	G1/2	3114 10 21

female stud elbow, BSP thread

## 3192



ØD	C	
4	G1/8	3192 04 10
4	G1/4	3192 04 13
6	G1/8	3192 06 10
6	G1/4	3192 06 13
8	G1/8	3192 08 10
8	G1/4	3192 08 13
10	G1/4	3192 10 13
10	G3/8	3192 10 17
10	G1/2	3192 10 21



# Threaded Fittings

male stud branch tee,  
BSPP and metric thread

**3198** ØD C

4	M5x0,8	3198 04 19
4	G1/8	3198 04 10
6	M5x0,8	3198 06 19
6	G1/8	3198 06 10
6	G1/4	3198 06 13
8	G1/8	3198 08 10
8	G1/4	3198 08 13
8	G3/8	3198 08 17
10	G1/4	3198 10 13
10	G3/8	3198 10 17
10	G1/2	3198 10 21

male stud run tee,  
BSPP and metric thread

**3193** ØD C

4	M5x0,8	3193 04 19
4	G1/8	3193 04 10
6	G1/8	3193 06 10
6	G1/4	3193 06 13
8	G1/8	3193 08 10
8	G1/4	3193 08 13
8	G3/8	3193 08 17
10	G1/4	3193 10 13
10	G3/8	3193 10 17
10	G1/2	3193 10 21

«Y» piece male,  
BSPP and metric thread

**3158** ØD C

4	M5x0,8	3158 04 19
4	G1/8	3158 04 10
4	G1/4	3158 04 13
6	G1/8	3158 06 10
6	G1/4	3158 06 13
8	G1/8	3158 08 10
8	G1/4	3158 08 13
8	G3/8	3158 08 17
10	G1/4	3158 10 13
10	G3/8	3158 10 17
10	G1/2	3158 10 21

double banjo,  
BSPP and metric thread

**3119** ØD C

4	M5x0,8	3119 04 19
4	G1/8	3119 04 10
6	G1/8	3119 06 10
6	G1/4	3119 06 13
8	G1/4	3119 08 13
8	G3/8	3119 08 17
10	G3/8	3119 10 17

twin banjo,  
BSPP and metric thread

**3149** ØD C

4	M5x0,8	3149 04 19
4	G1/8	3149 04 10
4	G1/4	3149 04 13
6	G1/8	3149 06 10
6	G1/4	3149 06 13
6	G3/8	3149 06 17
8	G1/4	3149 08 13
8	G3/8	3149 08 17
10	G3/8	3149 10 17

single banjo,  
BSPP and metric thread

**3118** ØD C

4	M5x0,8	3118 04 19
4	G1/8	3118 04 10
6	M5x0,8	3118 06 19
6	G1/8	3118 06 10
6	G1/4	3118 06 13
8	G1/8	3118 08 10
8	G1/4	3118 08 13
8	G3/8	3118 08 17
10	G1/4	3118 10 13
10	G3/8	3118 10 17
10	G1/2	3118 10 21

single banjo with female BSPP  
bolt, metric and BSPP thread

**3124** ØD C

4	M5x0,8	3124 04 19
4	G1/8	3124 04 10
6	G1/4	3124 06 13
8	G3/8	3124 08 17

Legris banjos allow easy access, even when connections are close together.

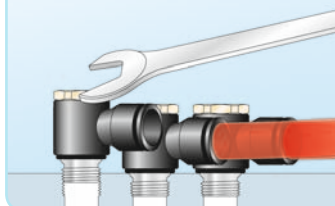

# Tube-to-Tube Fittings

tube/tube connector

**3106** ØD

4	3106 04 00
6	3106 06 00
8	3106 08 00
10	3106 10 00
12	3106 12 00
14	3106 14 00

equal elbow

**3102** ØD

4	3102 04 00
6	3102 06 00
8	3102 08 00
10	3102 10 00
12	3102 12 00
14	3102 14 00

equal and unequal tee

**3104** ØD1 ØD2

4	4	3104 04 00
4	6	3104 06 00
6	4	3104 06 04
8	8	3104 08 00
8	6	3104 08 06
10	10	3104 10 00
10	8	3104 10 08
12	12	3104 12 00
14	14	3104 14 00

single 'Y' piece –  
equal and unequal

**3140** ØD1 ØD2

4	4	3140 04 00
4	6	3140 04 06
6	6	3140 06 00
6	8	3140 06 08
8	8	3140 08 00

multiple «Y» piece -  
equal and unequal

**3144** ØD1 ØD2

4	4	3144 04 04
4	6	3144 04 06
6	6	3144 06 06
6	8	3144 06 08

multiple tee  
with fixing holes

**3304** ØD1 ØD2

6	4	3304 06 04
8	4	3304 08 04
8	6	3304 08 06
10	6	3304 10 06
10	8	3304 10 08

unequal multiple elbow  
with fixing holes

**3306** ØD1 ØD2

6	4	3306 06 04
8	4	3306 08 04
8	6	3306 08 06
10	6	3306 10 06
10	8	3306 10 08

equal cross,  
with fixing holes

**3107** ØD

4	3107 04 00
6	3107 06 00
8	3107 08 00

# Tube-to-Tube Bulkhead Fittings

bulkhead connector

**3116** 

ØD		
4		3116 04 00
6		3116 06 00
8		3116 08 00
10		3116 10 00
12		3116 12 00
14		3116 14 00



female bulkhead connector, BSPP thread

**3136** 

ØD	C	
4	G1/8	3136 04 10
4	G1/4	3136 04 13
6	G1/8	3136 06 10
6	G1/4	3136 06 13
8	G1/8	3136 08 10
8	G1/4	3136 08 13



equal bulkhead elbow

**3139** 

ØD		
4		3139 04 00
6		3139 06 00
8		3139 08 00

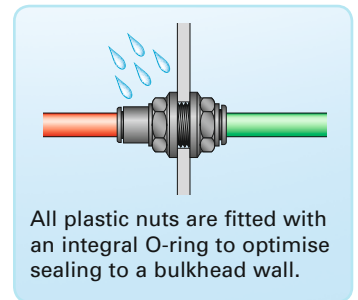
## Plug-In Fittings and Accessories

male standpipe, BSPT thread

**3121** 

ØD	C	
4	R1/8	3121 04 10
4	R1/4	3121 04 13
6	R1/8	3121 06 10
6	R1/4	3121 06 13
8	R1/8	3121 08 10
8	R1/4	3121 08 13
8	R3/8	3121 08 17
10	R1/4	3121 10 13
10	R3/8	3121 10 17
10	R1/2	3121 10 21
12	R3/8	3121 12 17
12	R1/2	3121 12 21
14	R1/2	3121 14 21



male standpipe, BSPP and metric thread

**3131** 

ØD	C	
4	M5x0,8	3131 04 19
4	G1/8	3131 04 10
4	G1/4	3131 04 13
6	G1/8	3131 06 10
6	G1/4	3131 06 13
8	G1/8	3131 08 10
8	G1/4	3131 08 13
8	G3/8	3131 08 17
10	G1/4	3131 10 13
10	G3/8	3131 10 17
10	G1/2	3131 10 21
12	G3/8	3131 12 17
12	G1/2	3131 12 21
14	G3/8	3131 14 17
14	G1/2	3131 14 21



plug-in equal compact elbow with plastic tailpiece

**3182** 

ØD	C	
4	4	3182 04 00
6	6	3182 06 00
8	8	3182 08 00



plug-in equal compact tee with plastic tailpiece

**3188** 

ØD	C	
4	4	3188 04 00
6	6	3188 06 00
8	8	3188 08 00



reducer

**3166** 

ØD	C	
4	6	3166 04 06
4	8	3166 04 08
6	8	3166 06 08
6	10	3166 06 10
8	10	3166 08 10
8	12	3166 08 12
8	14	3166 08 14
10	12	3166 10 12
10	14	3166 10 14
12	14	3166 12 14



increaser

**3168** 

ØD	C	
6	4	3168 06 04
8	6	3168 08 06
10	8	3168 10 08



double male stem connector

**3120** 

ØD		
4		3120 04 00
6		3120 06 00
8		3120 08 00
10		3120 10 00
12		3120 12 00
14		3120 14 00



blanking plug

**3126** 

ØD		
3		3126 03 00
4		3126 04 00
6		3126 06 00
8		3126 08 00
10		3126 10 00
12		3126 12 00
14		3126 14 00



## Multi-Connectors

male screw body

**3320** 

o.d. tube	number of outlets	
4	4	3320 04 00 04
4	7	3320 04 00 07
4	12	3320 04 00 12
6	4	3320 06 00 04
6	7	3320 06 00 07



female screw body

**3321** 

o.d. tube	number of outlets	
4	4	3321 04 00 04
4	7	3321 04 00 07
4	12	3321 04 00 12
6	4	3321 06 00 04
6	7	3321 06 00 07



screw cap

**3329** 

number of outlets	
4-7	3329 00 02
12	3329 00 03



Other special versions are also available. Please consult us.



# Flow Control Regulators

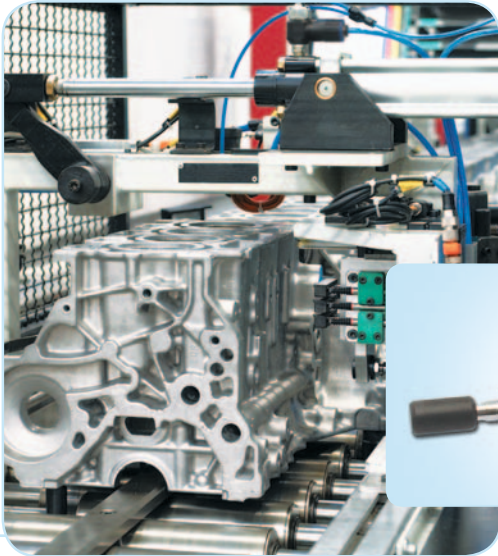

## Applications

■ Flow control regulators are used on pneumatic devices in many industrial applications : factory automation, packaging, multipurpose robots, material handling, textile, printing, auto process, machine tools.

## Function

■ They control the speed of a pneumatic cylinder. The exhaust air flow is controlled by an adjustable restrictor. The inlet flow is unrestricted full bore. These fittings are connected to the cylinder (exhaust version), to the control valve (supply version), or in the compressed air line (in-line version).

## Benefits

- perfectly controlled sealing both externally (tube outlet and sub-base) and internally (adjustment screw)
- stability, progressiveness and accuracy of flow
- LF 3000 instant connection ensures quick assembly
- designed for easy adjustment
- full flow in return direction

## Choosing a flow control regulator

### conditions of use

➤ standard conditions  
↓  
models in polymer

➤ severe conditions  
↓  
models in metal

### dimensions

➤ standard conditions with full flow performance  
↓  
compact models

➤ for very small cylinders with accurate adjustment  
↓  
miniature models

### type of adjustment

➤ manual adjustment  
↓  
models with external screw

➤ adjustment with screwdriver  
↓  
models with recessed screw

### configurations of the installation

➤ standard applications  
↓  
banjo types

➤ vertical or angled exit  
↓  
swivel outlet types

➤ difficult access of cylinder  
↓  
in-line types

To assist differentiation, each version is identified by the corresponding **pneumatic symbol** and a **letter** :

● one-way adjustment  
«exhaust» version :  
letter **A**



«supply» version :  
letter **B**



«bi-directional»  
version : letter **C**

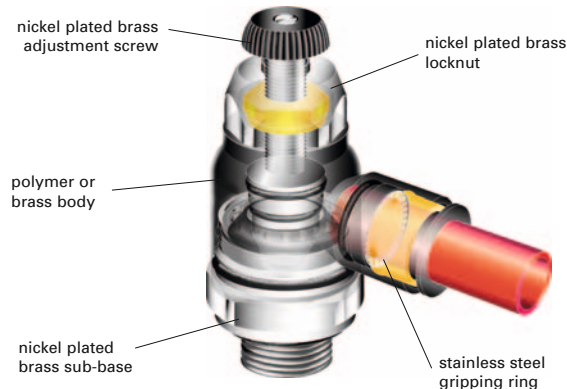

## Technical specifications

**suitable fluid :**  
compressed air

**working pressure :**  
1 to 10 bar

**working temperature :**  
0° to + 70°C

# Flow Control Regulators

## Polymer version

Designed to satisfy your requirements

### 7010



- the recessed adjustment screw reduces external dimensions thus allowing use in **reduced spaces** and **on small cylinders**
- the recessed screw provides **security** and helps to **prevent** unwanted adjustment.
- also available in metal version (7130)

with recessed adjustment screw, BSPP and metric thread



7010	7011	7012	ØD	C	exhaust (A)	supply (B)	bi-directional (C)
			4	M5x0,8	7010 04 19	7011 04 19	7012 04 19
			4	G1/8	7010 04 10	7011 04 10	7012 04 10
			6	M5x0,8	7010 06 19	7011 06 19	7012 06 19
			6	G1/8	7010 06 10	7011 06 10	7012 06 10
			6	G1/4	7010 06 13	7011 06 13	7012 06 13
			8	G1/8	7010 08 10	7011 08 10	7012 08 10
			8	G1/4	7010 08 13	7011 08 13	7012 08 13
			8	G3/8	7010 08 17	7011 08 17	7012 08 17
			10	G1/4	7010 10 13	7011 10 13	
			10	G3/8	7010 10 17	7011 10 17	
			10	G1/2	7010 10 21		
			12	G3/8	7010 12 17		
			12	G1/2	7010 12 21		

"compact", BSPP thread



7060	ØD	C
	4	G1/8 7060 04 10
	6	G1/8 7060 06 10
	6	G1/4 7060 06 13
	8	G1/8 7060 08 10
	8	G1/4 7060 08 13
	8	G3/8 7060 08 17
	10	G1/4 7060 10 13
	10	G3/8 7060 10 17
	12	G3/8 7060 12 17
	12	G1/2 7060 12 21

"miniature", BSPP and metric thread



7660	ØD	C
	4	M5x0,8 7660 04 19
	4	G1/8 7660 04 10
	6	M5x0,8 7660 06 19
	6	G1/8 7660 06 10
	6	G1/4 7660 06 13
	8	G1/8 7660 08 10
	8	G1/4 7660 08 13
	8	G3/8 7660 08 17

"miniature", BSPP and metric thread



7669	ØD	C
	4	M5x0,8 7669 04 19
	4	G1/8 7669 04 10
	6	M5x0,8 7669 06 19
	6	G1/8 7669 06 10
	6	G1/4 7669 06 13
	8	G1/8 7669 08 10
	8	G1/4 7669 08 13
	8	G3/8 7669 08 17

"compact", swivel outlet type, BSPP thread



7040	ØD	C
	6	G1/8 7040 06 10
	6	G1/4 7040 06 13
	8	G1/8 7040 08 10
	8	G1/4 7040 08 13
	8	G3/8 7040 08 17
	10	G1/4 7040 10 13
	10	G3/8 7040 10 17
	12	G3/8 7040 12 17
	12	G1/2 7040 12 21

in-line with instant connection



7770	ØD
	4 7770 04 00
	6 7770 06 00
	8 7770 08 00
	10 7770 10 00
	12 7770 12 00

in-line with instant connection, panel mountable



7776	ØD
	4 7776 04 00
	6 7776 06 00
	8 7776 08 00
	10 7776 10 00
	12 7776 12 00

plug-in type, "miniature"



7030	ØD
	6 7030 06 00
	8 7030 08 00
	10 7030 10 00
	12 7030 12 00

with external screw, "compact", BSPT thread



7065	ØD	C
	6	R1/8 7065 06 10
	8	R1/8 7065 08 10
	8	R1/4 7065 08 13
	10	R1/4 7065 10 13
	10	R3/8 7065 10 17
	10	R1/2 7065 10 21
	12	R1/4 7065 12 13
	12	R3/8 7065 12 17
	12	R1/2 7065 12 21

## Metal version

with recessed adjustment screw, BSPP and metric thread



7130	ØD	C
	4	M5x0,8 7130 04 19
	4	G1/8 7130 04 10
	6	M5x0,8 7130 06 19
	6	G1/8 7130 06 10
	6	G1/4 7130 06 13
	8	G1/8 7130 08 10
	8	G1/4 7130 08 13
	8	G3/8 7130 08 17
	10	G3/8 7130 10 17
	10	G1/2 7130 10 21
	12	G1/2 7130 12 21

"compact" with instant connection, BSPP thread



7100	ØD	C
	4	G1/8 7100 04 10
	6	G1/8 7100 06 10
	6	G1/4 7100 06 13
	8	G1/8 7100 08 10
	8	G1/4 7100 08 13
	8	G3/8 7100 08 17
	10	G1/4 7100 10 13
	10	G3/8 7100 10 17
	12	G3/8 7100 12 17
	12	G1/2 7100 12 21
	14	G1/2 7100 14 21

"compact" with threaded connection, BSPP thread



7110	C
	G1/8 7110 10 10
	G1/4 7110 13 13
	G3/8 7110 17 17
	G1/2 7110 21 21

with threaded connection and recessed adjustment screw, BSPP and metric thread



7140	ØD	C
	M5x0,8	7140 19 19
	G1/8	7140 10 10
	G1/4	7140 13 13
	G3/8	7140 17 17
	G1/2	7140 21 21

# Pneumatic Function Fittings

## Applications

Function fittings are used on pneumatic devices in many industrial applications: factory automation, packaging, multi-purpose robots, material handling, textile, printing, auto process, machine tools.

Here are few functions:

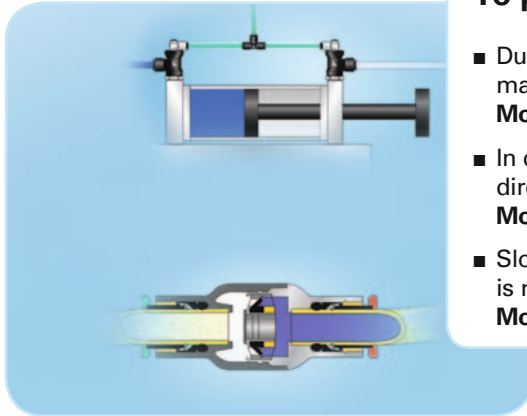

### To protect your installation

- During an emergency stop of a pneumatic installation, blocking fittings are designed to maintain loads.  
**Model 7881 - 7880**
- In case of failure of the power supply, non-return valves allow air to pass in one direction whilst blocking flow in the other.  
**Models : in polymer 7996 - 7994**
- Slow start fittings allow air to gradually increase when a compressed airline is restarted. This gradual pressure increase prevents shocks to the system.  
**Model 7870**

### To adjust performance of your installation

- In order to adjust pressure to the required value, pressure regulator fittings stabilize at a given value the pressure applied to pneumatic equipment, whatever the fluctuations of pressure upstream.  
**Model 7300**
- Pressure reducer fittings enable manual adjustment of the circuit pressure applied to pneumatic equipment, limiting the cylinder pressure.  
**Models 7316**



### To control your installation

- For immediate and direct opening/closure of specific area of your installation supply, manually operated valves require just a simple manual operation.  
**Models 7800**
- For immediate venting of a pneumatic circuit, pneumatic sleeve valves need only a straightforward lateral movement of the sleeve.  
**Model 0669**
- For closure/purge of a pneumatic circuit, mini-ball valves are very easy to use where access is difficult and space is at a premium.  
**Models 7913 - 7910**

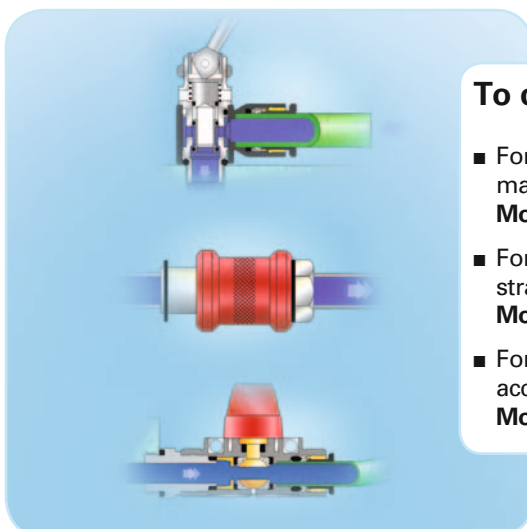

# Pneumatic Function Fittings

## Blocking fittings

male thread BSPP, with instant connection



**7880** ØD C

6	G1/8	7880 06 10
6	G1/4	7880 06 13
8	G1/4	7880 08 13
8	G3/8	7880 08 17
10	G3/8	7880 10 17
12	G1/2	7880 12 21

working pressure : 1 to 10 bar  
working temperature : -20° to + 70°C

male thread BSPP, with threaded connection



**7881** C1 C2

G1/8	G1/4	7881 13 10
G1/4	G1/4	7881 13 13
G3/8	G3/8	7881 17 17
G1/2	G1/2	7881 21 21

working pressure : 1 to 10 bar  
working temperature : -20° to + 70°C

## Non-return valves

in-line non-return valve with instant connection



**7996** ØD

4	7996 04 00
6	7996 06 00
8	7996 08 00
10	7996 10 00
12	7996 12 00

working pressure : 1 to 10 bar  
working temperature : 0° to + 70°C  
opening pressure: 0,3 bar

male thread, BSPP and metric, with instant connection



**7994** ØD C

4	M5x0,8	7994 04 19
4	G1/8	7994 04 10
6	G1/8	7994 06 10
6	G1/4	7994 06 13
8	G1/8	7994 08 10
8	G1/4	7994 08 13
10	G3/8	7994 10 17
12	G3/8	7994 12 17
12	G1/2	7994 12 21

## Manual operated vent fittings

pneumatic sleeve valve, double female, BSPP thread

**0669** C

M5x0,8	2	0669 02 19
G1/8	4	0669 04 10
G1/4	7	0669 07 13
G3/8	10	0669 10 17
G1/2	14	0669 14 21
G3/4	19	0669 19 27

working pressure : 16 bar  
working temperature : -10° to + 80°C

3/2 manual switch operated valve, with instant connection, BSPP and metric thread



**7800** ØD C

4	M5x0,8	7800 04 19
4	G1/8	7800 04 10
6	M5x0,8	7800 06 19
6	G1/8	7800 06 10
6	G1/4	7800 06 13
8	G1/8	7800 08 10
8	G1/4	7800 08 13
10	G1/4	7800 10 13

working pressure : 10 bar  
working temperature : -10° to + 80°C

## Mini ball valves

3/2, with vent, with instant connection



**7913** ØD

4	7913 04 00
6	7913 06 00
8	7913 08 00
10	7913 10 00
12	7913 12 00

working pressure : 1 to 10 bar  
working temperature : -20° to + 80°C

2/2, with instant connection

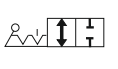

**7910** ØD

4	7910 04 00
6	7910 06 00
8	7910 08 00
10	7910 10 00
12	7910 12 00

working pressure : 1 to 10 bar  
working temperature : -20° to + 80°C

## Pressure regulator fittings

male BSPP, with instant connection



**7300** ØD C

4	G1/8	7300 04 10
6	G1/8	7300 06 10
6	G1/4	7300 06 13
8	G1/8	7300 08 10
8	G1/4	7300 08 13
8	G3/8	7300 08 17
10	G1/4	7300 10 13
10	G3/8	7300 10 17

working pressure :  
- input pressure : 1 to 16 bar  
- regulated pressure : 1 to 8 bar  
working temperature : -10° to + 70°C

## Pressure reducer fittings

in-line, with instant connection



**7316** ØD

6	7316 06 00
8	7316 08 00
10	7316 10 00

Working pressure : 1 to 8 bar  
Working temperature :  
- 15° to + 60°C

## Pneumatic sensor fittings

male thread BSPP and metric, with instant connection



**7818** C

M5x0,8	7818 04 19
G1/8	7818 04 10
G1/4	7818 04 13
G3/8	7818 04 17
G1/2	7818 04 21

Working pressure : 3 to 8 bar  
Working temperature :  
- 15° to + 60°C  
Breaking pressure : 0,6 bar  
Response time : 3 ms

## Pneumatic soft start fitting

for control valve with instant connection



**7870** ØD C

8	G1/4	7870 08 13
10	G1/4	7870 10 13
10	G3/8	7870 10 17

Working pressure: 3 to 10 bar  
Working temperature: -15° to + 60°C

# Carstick® Cartridges

Carstick®

Ideal for **continuous processes**, Carstick cartridge provides a **high performance** solution for automatic, semi-automatic and manual assembly equipment for pneumatic components. Please consult us for detailed drawings of cavity dimensions and tolerances. Special versions available on request.

**3100** ØD cartridge 

4	3100 04 00
6	3100 06 00
8	3100 08 00
10	3100 10 00
10	3100 12 00



## Benefits

- assembly time saving, with complete safety
- tried and tested technology
- optimised dimensions
- suitable for automatic processes
- closer mounting tolerances and shallow cavities

## Technical specifications

- Suitable fluid : compressed air
- Working pressure : maximum 20 bar
- Working temperature : - 20° to + 80°C



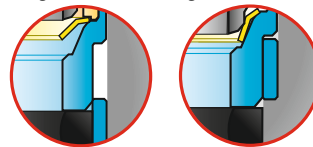
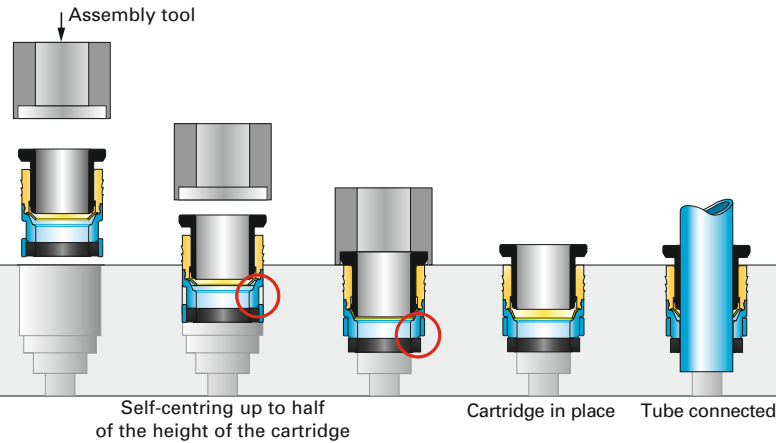



## Carstick® assembly



Depression of seal protection leaves seal locked into cavity

# Tamper-Evident Safety Clip

Tamper-Evident Safety Clip

clip	ØD						
6		3130 06 01	3130 06 02	3130 06 03	3130 06 04	3130 06 05	3130 06 10
8		3130 08 01	3130 08 02	3130 08 03	3130 08 04	3130 08 05	3130 08 10
10		3130 10 01	3130 10 02	3130 10 03	3130 10 04	3130 10 05	3130 10 10
12		3130 12 01	3130 12 02	3130 12 03	3130 12 04	3130 12 05	3130 12 10

## Assembly of the Tamper-Evident Safety Clip

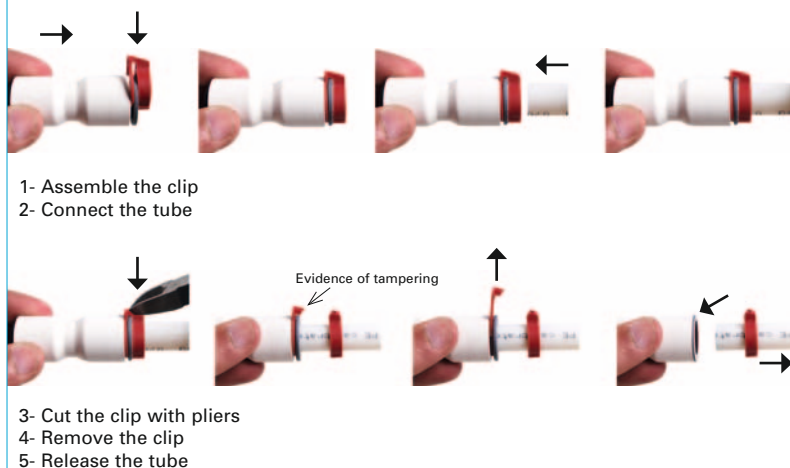

## Applications

- Pneumatic networks, water treatment device, water cooling

## Benefits

- Compatible with LF 3000 push-in fittings and pneumatic function fittings
- A solution that makes tampering obvious and warns that: the application is sensitive and that disconnection could endanger persons and goods
- The clip must be cut with pliers to disconnect the tube, limiting this operation to workers with a toolbox, and thus reinforcing the warning about disconnection
- Evidence of tampering is apparent after disconnection but the clip maintains its safety function
- Colour-coding enables fluid circuit identification (6 colours)

## Technical specifications

- suitable fluid : Air, grease, cleaning agents
- Working temperature : from -20°C to +150°C

## Materials

Polyamide 6-6 reinforced with fiberglass

# Universal Compression Fittings



## ■ a solution for all applications

- **Full range:** wide variety of body designs and numerous configurations from 4 to 28 mm diameters
- **Two materials:** brass and stainless steel for more fluid compatibility conveying
- **3 types of threads :** BSP parallel (BSPP), BSP taper (BSPT) and metric

You will find the range of **stainless steel universal compression fittings** on page 22.

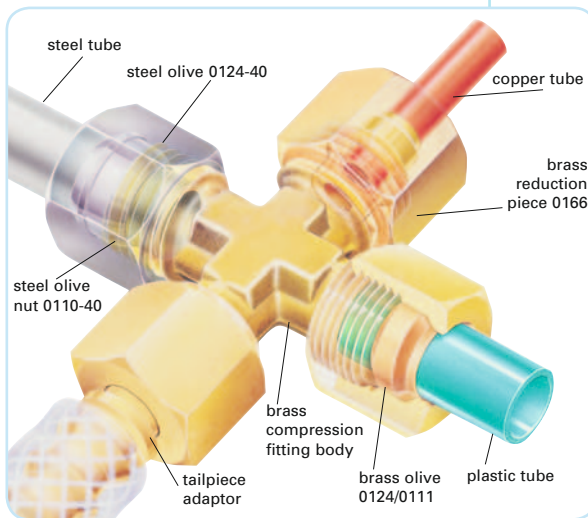

## Applications

- The universal range of compression fittings is the solution to all fluid distribution and connection problems.  
The universal compression fittings meet the latest regulations in effect: **RoHS, PED, ATEX and REACH.** It is especially adapted the **CNOMO** standards for manufacturing equipment in the automotive industry.

## Benefits

- **Connection of different materials and diameters of tubing,** offering a maximum number of connection possibilities with direct assembly
- **Space-saving,** allowing different connection configurations with the same fitting
- **Absence of seal,** guarantee maintenance simplification, an increase in the installations lifespan and lower risk of leakage authorizing the transportation of some fluids

## Technical specifications

### Suitable fluids :

used for conveying various types of liquids : water, cutting oil, fuel, hydraulic oil, compressed air, chemical fluids, disinfectant or food and beverages\*.  
\* According to the regulation for material in contact with foodstuff

### Maximal Working Pressure :

550 bars\* (\*\*)

\*Depending on the tubing material and connection diameters

\*\* For nylon tubing the maximum allowable working pressure is 40 bar depending on diameters and safety coefficient

### Working temperature :

-40°C to 250°C\*

\*According to material of the tubing

### Vacuum capability :

Industrial vacuum : 1013 to 1 mm de Hg

## Stud couplings

male stud coupling, BSPT thread

male stud elbow, BSPT thread

male stud coupling, BSPP and metric thread

single banjo, BSPP thread

**0105** ØD C

6	R1/8	0105 06 10
6	R1/4	0105 06 13
8	R1/8	0105 08 10
8	R1/4	0105 08 13
8	R3/8	0105 08 17
10	R1/4	0105 10 13
10	R3/8	0105 10 17
12	R3/8	0105 12 17
12	R1/2	0105 12 21
16	R1/4	0105 16 13
18	R1/2	0105 18 21

**0109** ØD C

6	R1/8	0109 06 10
6	R1/4	0109 06 13
8	R1/8	0109 08 10
8	R1/4	0109 08 13
10	R1/4	0109 10 13
10	R3/8	0109 10 17
12	R1/4	0109 12 13
12	R1/2	0109 12 21
16	R1/2	0109 16 21

**0101** ØD C

4	M8x1	0101 04 56
6	G1/8	0101 06 10
6	G1/4	0101 06 13
6	M10x1	0101 06 60
8	G1/8	0101 08 10
8	G1/4	0101 08 13
10	G1/4	0101 10 13
10	G3/8	0101 10 17
12	G3/8	0101 12 17
16	G1/2	0101 16 21

**0118** ØD C

6	G1/8	0118 06 10
6	G1/4	0118 06 13
8	G1/8	0118 08 10
8	G1/4	0118 08 13
10	G1/4	0118 10 13
10	G3/8	0118 10 17
12	G3/8	0118 12 17
16	G1/2	0118 16 21

## Tube-to-tube couplings

equal straight coupling

equal tee

equal elbow

tailpiece adaptor for rubber hose

**0106** ØD

4	0106 04 00
5	0106 05 00
6	0106 06 00
8	0106 08 00
10	0106 10 00
12	0106 12 00
14	0106 14 00
16	0106 16 00
18	0106 18 00
22	0106 22 00

**0104** ØD

4	0104 04 00
6	0104 06 00
8	0101 08 00
10	0104 10 00
12	0104 12 00
14	0104 14 00
15	0104 15 00
16	0104 16 00
18	0104 18 00
22	0104 22 00

**0102** ØD

6	0102 06 00
8	0102 08 00
10	0102 10 00
12	0102 12 00
14	0102 14 00
15	0102 15 00
16	0102 16 00
18	0102 18 00
20	0102 20 00
22	0102 22 00

**0122** ØD1ØD2

4	4	0122 04 04
5	4	0122 05 04
6	4	0122 06 04
8	6	0122 08 06
10	7	0122 10 07
12	10	0122 12 10
14	13	0122 14 13
15	13	0122 15 13
16	13	0122 16 13
18	16	0122 18 16



# LF 3600 Chemical Nickel-Plated Brass Instant Fittings

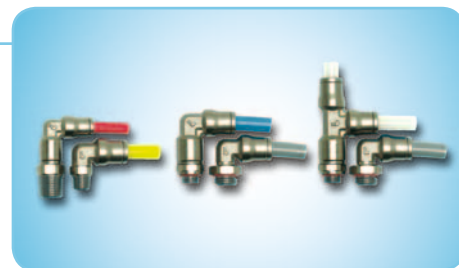
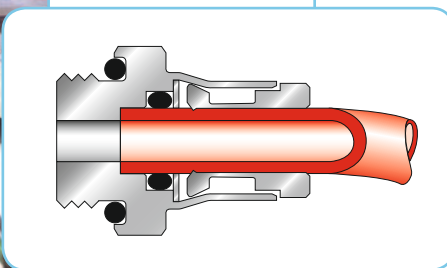

## Applications

- LF 3600 is compatible with **many liquids and gases** and is ideal for environments that require mechanical strength.
- suited to many specialist applications : **industrial, chemical, pharmaceutical, food** applications, **automation** and **medical** industries.

## Benefits

- **Enhanced technical performance fittings:**
  - Excellent resistance to high temperature, pressure and vacuum- An HACCP-improved product with particularly long threads to resist shocks, stress and vibrations- Spring collet gripping for long-term resistance- Excellent resistance to abrasion and corrosion due to high phosphorus chemical nickel plating of individual brass components
  - Full flow fluid passage, minimal pressure drop

- **Suitable for many specialized applications, including those in the food industry:**

Materials conform to FDA standards and to 1935/2004/CE European directive

- **Time-saving and ease of installation:**  
Instant manual connection and disconnection
- **Compactness** thanks to small overall dimensions with interconnectability for creating specific combinations
- Unit quality control and dating to guarantee quality and traceability of products
- The widest range on the market: more than 170 part numbers

## Technical specifications

**suitable fluids :**  
all liquids and gases compatible with the materials of the fitting.

Examples : compressed air, cleaning/cold and hot water, steam, oils ...

**working pressure :**  
maximum 30 bar, except 3609 and 3699.

**working temperature :**  
- 20° to + 150°C.

**vacuum capability :**  
vacuum of 755 Hmg (99% vacuum)

- **ability to suit your requirements**

Legris has developed semi-standard **LF 3600 models** for **specific applications** such as coffee machines, medical applications, car painting lines and printing machines. Do not hesitate to contact us for further information.

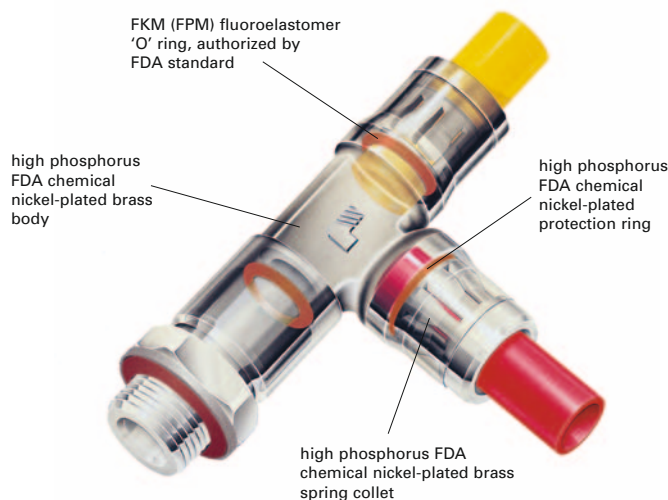

All items in the LF 3600 range are guaranteed **silicone free**.

**maximum tightening torque for LF 3600® fittings, BSPP and metric threads**

Thread	M5 x0,8	G1/8"	G1/4"	G3/8"	G1/2"
da N.m	0,16	0,8	1,2	3	3,5

# LF3600 Chemical Nickel-plated Brass Instant Fittings

## Designed to satisfy your requirements

### 3601



- automatic sealing of parallel thread via an integral sub-base FKM seal
- internal hexagon for installation in tight places
- high phosphorus chemical nickel plating of individual brass components for an excellent resistance to abrasion and corrosion
- «all metal» components (except seals) that allow working temperature from -20° to +150°C

You will find our range of brass function fittings on page 13.

## male stud, BSPP and metric thread

3601	ØD	C	
4	M5x0,8	3601 04 19	
4	G1/8	3601 04 10	
4	G1/4	3601 04 13	
6	M5x0,8	3601 06 19	
6	G1/8	3601 06 10	
6	G1/4	3601 06 13	
8	G1/8	3601 08 10	
8	G1/4	3601 08 13	
8	G3/8	3601 08 17	
10	G1/4	3601 10 13	
10	G3/8	3601 10 17	
10	G1/2	3601 10 21	
12	G1/4	3601 12 13	
12	G3/8	3601 12 17	
12	G1/2	3601 12 21	
14	G3/8	3601 14 17	
14	G1/2	3601 14 21	

## male stud BSPT thread

3675	ØD	C	
4	R1/8	3675 04 10	
4	R1/4	3675 04 13	
6	R1/8	3675 06 10	
6	R1/4	3675 06 13	
8	R1/8	3675 08 10	
8	R1/4	3675 08 13	
8	R3/8	3675 08 17	
10	R1/4	3675 10 13	
10	R3/8	3675 10 17	
10	R1/2	3675 10 21	
12	R1/4	3675 12 13	
12	R3/8	3675 12 17	
12	R1/2	3675 12 21	
14	R3/8	3675 14 17	
14	R1/2	3675 14 21	

## male stud elbow, BSPP and metric thread

3699*	ØD	C	
4	M5x0,8	3699 04 19	
4	G1/8	3699 04 10	
4	G1/4	3699 04 13	
6	G1/8	3699 06 10	
6	G1/4	3699 06 13	
8	G1/8	3699 08 10	
8	G1/4	3699 08 13	
8	G3/8	3699 08 17	
10	G1/4	3699 10 13	
10	G3/8	3699 10 17	
12	G1/4	3699 12 13	
12	G3/8	3699 12 17	
12	G1/2	3699 12 21	
14	G3/8	3699 14 17	
14	G1/2	3699 14 21	

\* 20 bar maxi

## male stud elbow, BSPT thread

3609*	ØD	C	
4	R1/8	3609 04 10	
4	R1/4	3609 04 13	
6	R1/8	3609 06 10	
6	R1/4	3609 06 13	
8	R1/8	3609 08 10	
8	R1/4	3609 08 13	
8	R3/8	3609 08 17	
10	R1/4	3609 10 13	
10	R3/8	3609 10 17	
12	R1/4	3609 08 17	
12	R3/8	3609 12 17	
12	R1/2	3609 12 21	
14	R3/8	3609 14 17	
14	R1/2	3609 14 21	

\* 20 bar maxi

## extended male stud elbow, BSPP and metric thread

3669	ØD	C	
4	M5x0,8	3669 04 19	
4	G1/8	3669 04 10	
6	G1/8	3669 06 10	
6	G1/4	3669 06 13	
8	G1/8	3669 08 10	
8	G1/4	3669 08 13	

## female stud, metric thread

3614	ØD	C	
4	G1/8	3614 04 10	
4	G1/4	3614 04 13	
6	G1/8	3614 06 10	
6	G1/4	3614 06 13	
8	G1/8	3614 08 10	
8	G1/4	3614 08 13	

## male stud branch tee, BSPP and metric thread

3698	ØD	C	
4	M5x0,8	3698 04 19	
4	G1/8	3698 04 10	
6	G1/8	3698 06 10	
6	G1/4	3698 06 13	
8	G1/8	3698 08 10	
8	G1/4	3698 08 13	

## male stud run tee, BSPP and metric thread

3693	ØD	C	
4	M5x0,8	3693 04 19	
4	G1/8	3693 04 10	
6	G1/8	3693 06 10	
6	G1/4	3693 06 13	
8	G1/8	3693 08 10	
8	G1/4	3693 08 13	

## equal tee

3604	ØD	
4	3604 04 00	
6	3604 06 00	
8	3604 08 00	
10	3604 10 00	
12	3604 12 00	
14	3604 14 00	

## equal tube to tube connector

3606	ØD	
4	3606 04 00	
6	3606 06 00	
8	3606 08 00	
10	3606 10 00	
12	3606 12 00	
14	3606 14 00	

## equal elbow

3602	ØD	
4	3602 04 00	
6	3602 06 00	
8	3602 08 00	
10	3602 10 00	
12	3602 12 00	
14	3602 14 00	

## single banjo, BSPP and metric thread

3618	ØD	C	
4	M5x0,8	3618 04 19	
4	G1/8	3618 04 10	
6	M5x0,8	3618 06 19	
6	G1/8	3618 06 10	
6	G1/4	3618 06 13	
8	G1/8	3618 08 10	
8	G1/4	3618 08 13	
10	G3/8	3618 10 17	

## equal bulkhead connector

3616	ØD	
4	3616 04 00	
6	3616 06 00	
8	3616 08 00	
10	3616 10 00	
12	3616 12 00	
14	3616 14 00	

## equal bulkhead elbow

3639	ØD	
4	3639 04 00	
6	3639 06 00	
8	3639 08 00	
10	3639 10 00	
12	3639 12 00	
14	3639 14 00	

## plug-in reducer

3666	ØD1	ØD2	
4	6	3666 04 06	
4	8	3666 04 08	
6	8	3666 06 08	
6	10	3666 06 10	
6	12	3666 06 12	
8	10	3666 08 10	
8	12	3666 08 12	
8	14	3666 08 14	
10	12	3666 10 12	
10	14	3666 10 14	
12	14	3666 12 14	

## blanking plug

3626	ØD1	ØD2	
4	6	3626 04 00	
6	8	3626 06 00	
8	10	3626 08 00	
10	12	3626 10 00	
12	14	3626 12 00	
14	16	3626 14 00	

# Accessories and Plugs

In order to offer **total connection** solutions, **Legris** provides users with a range of accessories and plugs, **suitable** for use with the different models featured in this Product Guide.

## Nickel-plated Brass Accessories

### Designed to satisfy your requirements

## 0904



- enable **adaptation** to different types of female threads
- help to **minimise** stock holdings by limiting the number of part numbers to be used
- enhances the aesthetic appearance of installations
- optimized dimensions

### straight male equal/unequal adapter, BSPT thread

## 0900



C1	C2	
R1/8	R1/8	0900 00 10
R1/4	R1/4	0900 00 13
R3/8	R3/8	0900 00 17
R1/2	R1/2	0900 00 21
R3/4	R3/4	0900 00 27
R1"	R1"	0900 00 34
R1/8	R1/4	0900 10 13
R1/8	R3/8	0900 10 17
R1/4	R3/8	0900 13 17
R1/4	R1/2	0900 13 21
R3/8	R1/2	0900 17 21
R1/2	R3/4	0900 21 27
R3/4	R1"	0900 27 34

### tailpiece adaptor for rubber hose, male BSPP thread

## 0931



ØD	C	
6	G1/8	0931 06 10
6	G1/4	0931 06 13
7	G1/8	0931 07 10
7	G1/4	0931 07 13
7	G3/8	0931 07 17
8	G1/8	0931 08 10
8	G1/4	0931 08 13
8	G3/8	0931 08 17
10	G1/4	0931 10 13
10	G3/8	0931 10 17
10	G1/2	0931 10 21
15	G3/8	0931 15 17
15	G1/2	0931 15 21
18	G1/2	0931 18 21

### equal female stud elbow BSPP, male BSPT and metric thread

## 0913



C1	C2	
G1/8	R1/8	0913 00 10
G1/4	R1/4	0913 00 13
G3/8	R3/8	0913 00 17
G1/2	R1/2	0913 00 21
G3/4	R3/4	0913 00 27

### reducer male BSPT to female BSPP thread

## 0904



C1	C2	
R1/4	G1/8	0904 10 13
R3/8	G1/8	0904 10 17
R3/8	G1/4	0904 13 17
R1/2	G1/4	0904 13 21
R1/2	G3/8	0904 17 21
R3/4	G3/8	0904 17 27
R3/4	G1/2	0904 21 27

### equal female stud elbow, BSPP and metric thread

## 0912



C	
M5x0,8	0912 00 19
G1/8	0912 00 10
G1/4	0912 00 13
G3/8	0912 00 17
G1/2	0912 00 21
G3/4	0912 00 27

### equal male stud elbow, BSPT thread

## 0914



C	
R1/8	0914 00 10
R1/4	0914 00 13
R3/8	0914 00 17
R1/2	0914 00 21
R3/4	0914 00 27

### equal female tee, BSPP and metric thread

## 0915



C	
M5x0,8	0915 00 19
G1/8	0915 00 10
G1/4	0915 00 13
G3/8	0915 00 17
G1/2	0915 00 21
G3/4	0915 00 27

### equal "Y" female BSPP thread

## 0910



C	
G1/8	0910 00 10
G1/4	0910 00 13
G3/8	0910 00 17
G1/2	0910 00 21

### male stud branch tee, female BSPP, male BSPT thread

## 0916



C1	C2	
G1/8	R1/8	0916 00 10
G1/4	R1/4	0916 00 13
G3/8	R3/8	0916 00 17
G1/2	R1/2	0916 00 21
G3/4	R3/4	0916 00 27

### equal female cross, BSPP thread

## 0908



C	
G1/8	0908 00 10
G1/4	0908 00 13
G3/8	0908 00 17
G1/2	0908 00 21

### reducer male to female BSPP and metric thread

## 0905

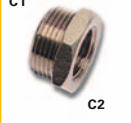

C1	C2	
G1/8	M5x0,8	0905 19 10
G1/4	G1/8	0905 10 13
G3/8	G1/8	0905 10 17
G3/8	G1/4	0905 13 17
G1/2	G1/4	0905 13 21
G1/2	G3/8	0905 17 21
G3/4	G3/8	0905 17 27
G3/4	G1/2	0905 21 27

### equal extended adaptor male/female BSPP thread

## 0907



C	
G1/8	0907 00 10
G1/4	0907 00 13

### straight female, equal/unequal, BSPP and metric thread

## 0902



C1	C2	
M5x0,8	G1/8	0902 19 10
M5x0,8	M5x0,8	0902 00 19
G1/8	G1/8	0902 00 10
G1/4	G1/4	0902 00 13
G3/8	G3/8	0902 00 17
G1/2	G1/2	0902 00 21
G3/4	G3/4	0902 00 27
G1/8	G1/4	0902 10 13
G1/4	G3/8	0902 13 17

### female bulkhead connector, BSPP and metric thread

## 0920



C1	C2	
M5x0,8	M10x1	0920 00 19
G1/8	M16x1,5	0920 00 10
G1/4	M20x1,5	0920 00 13
G3/8	M26x1,5	0920 00 17
G1/2	M28x1,5	0920 00 21

Technical specifications of nickel-plated brass accessories  
 working pressure : maximum 60 bar  
 working temperature : -10° to + 80°C

reducer male to female,  
BSPP and metric thread

**0178**

C1	C2	
M7x1	M5x0,8	0178 55 19
G1/8	M5x0,8	0178 10 19
G1/4	G1/8	0178 13 10
G3/8	G1/8	0178 17 10
G3/8	G1/4	0178 17 13
G1/2	G1/4	0178 21 13
G1/2	G3/8	0178 21 17
G3/4	G1/2	0178 27 21



increaser male to female,  
BSPP and metric thread

**0179**

C1	C2	
M12x1,5	G1/4	0179 67 13
G1/8	G1/4	0179 10 13
G1/4	G3/8	0179 13 17
G3/8	G1/2	0179 17 21



clip for tubes

**clip**

ØD	
4	Clip 04 00
6	Clip 06 00
8	Clip 08 00
10	Clip 10 00
12	Clip 12 00
14	Clip 14 00



## Plugs

internal hexagon head  
BSPT thread

**0205**

C	
R1/8	0205 10 00
R1/4	0205 13 00
R3/8	0205 17 00
R1/2	0205 21 00
R3/4	0205 27 00
R1"	0205 34 00
R1"1/4	0205 42 00



brass

threaded plug,  
BSPP and metric thread

**0222**

C	
M5x08	0222 19 00
M7x1	0222 55 00
G1/8	0222 10 00
G1/4	0222 13 00
G3/8	0222 17 00
G1/2	0222 21 00



## Sealing Accessories

copper washers

**0138**

ØD	C	
10	G1/8	0138 10 00
13	G1/4	0138 13 00
17	G3/8	0138 17 00
21	G1/2	0138 21 00
27	G3/4	0138 27 00
33	G1"	0138 33 00



fluoropolymer tape

**0605**

0605 12 12



working temperature:  
-250° to +260°C

## Silencers

threaded silencer,  
BSPP thread

**0670**

C	
G1/8	0670 00 10
G1/4	0670 00 13
G3/8	0670 00 17
G1/2	0670 00 21
G3/4	0670 00 27



sintered bronze  
working pressure: 12 bar  
working temp.: -20° to +150°C

threaded silencer,  
BSPP and metric thread

**0673**

C	
M5x0,8	0673 00 19
G1/8	0673 00 10
G1/4	0673 00 13
G3/8	0673 00 17
G1/2	0673 00 21



brass and sintered bronze  
working pressure: 12 bar  
working temp.: -20° to +150°C

flow control silencer,  
BSPP thread

**0672**

C	
G1/8	0672 00 10
G1/4	0672 00 13
G3/8	0672 00 17
G1/2	0672 00 21



brass and sintered bronze  
working pressure: 12 bar  
working temp.: -20° to +150°C

threaded silencer,  
BSPP and metric thread

**0674**

C	
M5x0,8	0674 00 19
G1/8	0674 00 10
G1/4	0674 00 13
G3/8	0674 00 17
G1/2	0674 00 21
G3/4	0674 00 27



polyethylene  
working pressure: 10 bar  
working temp.: -10° to +80°C

## Aluminium anodised manifolds

manifold with instant  
connection

**3310**

ØD	C	Nb of outlets	
4	G1/4	8	3310 04 13
6	G1/4	8	3310 06 13
8	G3/8	6	3310 08 17
10	G1/2	6	3310 10 21
12	G1/2	6	3310 12 21



female manifold  
BSPP and metric thread

**3311**

C1	C2	Nb of outlets	
G1/8	M5x0,8	7	3311 19 10 07
G1/4	G1/8	2	3311 10 13 02
G1/4	G1/8	3	3311 10 13 03
G1/4	G1/8	4	3311 10 13 04
G1/4	G1/8	5	3311 10 13 05
G1/4	G1/8	6	3311 10 13 06
G3/8	G1/4	2	3311 13 17 02
G3/8	G1/4	3	3311 13 17 03
G3/8	G1/4	4	3311 13 17 04
G3/8	G1/4	5	3311 13 17 05
G3/8	G1/4	6	3311 13 17 06



female cross manifold  
BSPP and metric thread

**3312**

C	
M5x0,8	3312 00 19
G1/8	3312 00 10
G1/4	3312 00 13
G3/8	3312 00 17
G1/2	3312 00 21



Technical specifications of  
aluminium anodised manifolds  
working pressure : maximum 20 bar  
working temperature : -10° to + 80°C

# Stainless Steel Fittings: LF 3900/LF 3900 Instant Fittings and Function Fittings



## Hygienic design

- Self draining design naturally ensures the dispersion of external fluids
- A very smooth polished surface design aimed at reducing retention zones for safe and easy cleaning



## Applications

- food process
- medical and pharmaceutical industries
- chemical and petrochemical industries
- paper industry

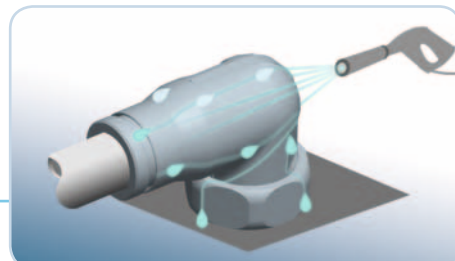
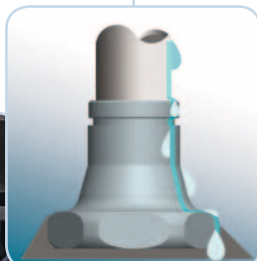

## Benefits

### Reliable and robust design

- **Proven gripping technology**
  - The collet guarantees excellent gripping and improved pull-out forces for soft tubing.
  - The collet is resistant to mechanical shocks and prevents whiplash, in particular when using metallic (pre-grooved) tubing.
- **Simple and reliable design.**
- **100 % unit control and dating of manufactured components** in order to guarantee quality, traceability and performance.
- **FKM seal** resistant to the majority of aggressive chemicals.
- **Pressure rating : 30 bar, temperature capability : 120°C.**
- **Sealed bulkhead connectors** (to IP51) enabling complete protection against detrimental ingress in dry and moist zone areas.

## Technical specifications

### suitable fluids :

all fluids compatible with fitting and tubing materials

### working pressure :

30 bar\* maximum dependant on tubing used

\* except part numbers 3979/3879 and 3989/3889

### working temperature :

from -20° to +120°C\* dependant on the type and size of tubing

\*For higher temperatures (up to 150°C), please do not hesitate to contact us.

### Materials :

- body : stainless steel 316L
- collet :
  - stainless steel 316L (LF 3900)
  - stainless steel 303 (LF 3800)
- washer : stainless steel 316L
- «O» ring : FKM

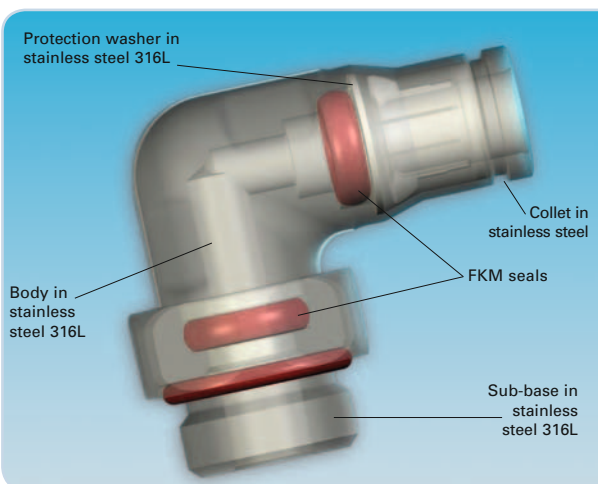

### Tightening torque for bulkhead fittings with O-ring

Maximum tightening torque for BSPP threads with O-ring	Thread	Maxi tightening torque	Tightening torque for bulkhead washer	Diameter	Mini tightening torque	Maxi tightening torque
	M5	0.16 daN.m		Tightening torque for bulkhead washer	4 mm	0.5 daN.m
G1/8	0.8 daN.m	6 mm	0.5 daN.m		0.9 daN.m	
G1/4	1.2 daN.m	8 mm	0.6 daN.m		1 daN.m	
G3/8	3 daN.m	10 mm	0.6 daN.m		1 daN.m	
G1/2	3.5 daN.m	12 mm	0.6 daN.m		1 daN.m	

# LF 3900 and LF 3800 Stainless Steel Instant Fittings and Function Fittings

male stud fitting, BSPT thread

3905 3805	ØD	C	LF 3900	LF 3800
	4	R1/8	3905 04 10	3805 04 10
	4	R1/4	3905 04 13	3805 04 13
	6	R1/8	3905 06 10	3805 06 10
	6	R1/4	3905 06 13	3805 06 13
	8	R1/8	3905 08 10	3805 08 10
	8	R1/4	3905 08 13	3805 08 13
	8	R3/8	3905 08 17	3805 08 17
	10	R1/4	3905 10 13	3805 10 13
	10	R3/8	3905 10 17	3805 10 17
	12	R1/4	3905 12 13	3805 12 13
	12	R3/8	3905 12 17	3805 12 17
	12	R1/2	3905 12 21	3805 12 21

male stud fitting, BSPP and metric thread

3901 3801	ØD	C	LF 3900	LF 3800
	4	M5x0,8	3901 04 19	3801 04 19
	4	G1/8	3901 04 10	3801 04 10
	6	M5x0,8	3901 06 19	3801 06 19
	6	G1/8	3901 06 10	3801 06 10
	6	G1/4	3901 06 13	3801 06 13
	8	G1/8	3901 08 10	3801 08 10
	8	G1/4	3901 08 13	3801 08 13
	8	G3/8	3901 08 17	3801 08 17
	10	G1/4	3901 10 13	3801 10 13
	10	G3/8	3901 10 17	3801 10 17
	12	G1/4	3901 12 13	3801 12 13
	12	G3/8	3901 12 17	3801 12 17

male standpipe, BSPT thread

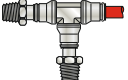
3821	ØD	C	
	4	R1/8	3821 04 10
	6	R1/8	3821 06 10
	6	R1/4	3821 06 13
	8	R1/8	3821 08 10
	8	R1/4	3821 08 13
	10	R1/4	3821 10 13
	10	R3/8	3821 10 17
	12	R1/4	3821 12 13
	12	R3/8	3821 12 17
	12	R1/2	3821 12 21

male standpipe, BSPP and metric thread

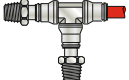
3831	ØD	C	
	4	M5x0,8	3831 04 19
	4	G1/8	3831 04 10
	4	G1/4	3831 04 13
	6	G1/8	3831 06 10
	6	G1/4	3831 06 13
	8	G1/8	3831 08 10
	8	G1/4	3831 08 13
	8	G3/8	3831 08 17
	10	G1/4	3831 10 13
	10	G3/8	3831 10 17
	12	G1/4	3831 12 13
	12	G3/8	3831 12 17
	12	G1/2	3831 12 21

compact male stud elbow, BSPT thread

3989* 3889*	ØD	C	LF 3900	LF 3800
	4	R1/8	3989 04 10	3889 04 10
	4	R1/4	3989 04 13	3889 04 13
	6	R1/8	3989 06 10	3889 06 10
	6	R1/4	3989 06 13	3889 06 13
	8	R1/8	3989 08 10	3889 08 10
	8	R1/4	3989 08 13	3889 08 13
	8	R3/8	3989 08 17	3889 08 17
	10	R1/4	3989 10 13	3889 10 13
	10	R3/8	3989 10 17	3889 10 17
	12	R1/4	3989 12 13	3889 12 13
	12	R3/8	3989 12 17	3889 12 17
	12	R1/2	3989 12 21	3889 12 21

\* 20 bar maxi

compact male stud elbow, BSPP thread

3979* 3879*	ØD	C	LF 3900	LF 3800
	4	G1/8	3979 04 10	3879 04 10
	4	G1/4	3979 04 13	3879 04 13
	6	G1/8	3979 06 10	3879 06 10
	6	G1/4	3979 06 13	3879 06 13
	8	G1/8	3979 08 10	3879 08 10
	8	G1/4	3979 08 13	3879 08 13
	8	G3/8	3979 08 17	3879 08 17
	10	G1/4	3979 10 13	3879 10 13
	10	G3/8	3979 10 17	3879 10 17
	12	G1/4	3979 12 13	3879 12 13
	12	G3/8	3979 12 17	3879 12 17
	12	G1/2	3979 12 21	3879 12 21

\* 20 bar maxi

equal elbow

3902 3802	ØD	LF 3900	LF 3800
	4	3902 04 00	3802 04 00
	6	3902 06 00	3802 06 00
	8	3902 08 00	3802 08 00
	10	3902 10 00	3802 10 00
	12	3902 12 00	3802 12 00

equal tube-to-tube connector

3906 3806	ØD	LF 3900	LF 3800
	4	3906 04 00	3806 04 00
	6	3906 06 00	3806 06 00
	8	3906 08 00	3806 08 00
	10	3906 10 00	3806 10 00
	12	3906 12 00	3806 12 00

equal tee

3904 3804	ØD	LF 3900	LF 3800
	4	3904 04 00	3804 04 00
	6	3904 06 00	3804 06 00
	8	3904 08 00	3804 08 00
	10	3904 10 00	3804 10 00
	12	3904 12 00	3804 12 00

equal bulkhead connector

3916 3816	ØD	LF 3900	LF 3800
	4	3916 04 00	3816 04 00
	6	3916 06 00	3816 06 00
	8	3916 08 00	3816 08 00
	10	3916 10 00	3816 10 00
	12	3916 12 00	3816 12 00

reducer

3966 3866	ØD1	ØD2	LF 3900	LF 3800
	4	6	3966 04 06	3866 04 06
	4	8	3966 04 08	3866 04 08
	6	8	3966 06 08	3866 06 08
	6	10	3966 06 10	3866 06 10
	8	10	3966 08 10	3866 08 10
	8	12	3966 08 12	3866 08 12
	10	12	3966 10 12	3866 10 12

## Quick exhaust valve Flow control regulators

double female, BSPP thread

7899	ØD	DN	
	G1/8	7	7899 00 10
	G1/4	7	7899 00 13
	G3/8	9	7899 00 17
	G1/2	12	7899 00 21
	G3/4	18	7899 00 27
	G1"	18	7899 00 34

with threaded fitting, BSPP and metric - recessed adjustment screw



7810	C1-C2	
	G1/8	7810 10 10
	G1/4	7810 13 13
	G3/8	7810 17 17
	G1/2	7810 21 21

for pneumatic applications

with threaded fitting, BSPP and metric - recessed adjustment screw



7812	C1-C2	
	G1/8	7812 10 10
	G1/4	7812 13 13
	G3/8	7812 17 17
	M5x0,8	7812 19 19
	G1/2	7812 21 21

for pneumatic applications

## Non-return valves

unidirectional, female-female, BSPP thread



4890	C	DN	
	G1/8	10	4890 10 10
	G1/4	10	4890 13 13
	G3/8	15	4890 17 17
	G1/2	15	4890 21 21
	G3/4	20	4890 27 27
	G1"	25	4890 34 34

# Stainless Steel Accessories

equal elbow,  
female BSPP thread

**1843** C 

Ø	C	Part No.
G1/8		1843 10 10
G1/4		1843 13 13
G3/8		1843 17 17
G1/2		1843 21 21



equal tee,  
triple female BSPP thread

**1845** C 

Ø	C	Part No.
G1/8		1845 10 10
G1/4		1845 13 13
G3/8		1845 17 17
G1/2		1845 21 21



double female sleeve,  
BSPP thread

**1855** C 

Ø	C	Part No.
G1/8		1855 10 10
G1/4		1855 13 13
G3/8		1855 17 17
G1/2		1855 21 21



bulkhead adaptor,  
BSPP thread

**1817** C 

Ø	C	Part No.
G1/8		1817 00 10
G1/4		1817 00 13
G3/8		1817 00 17
G1/2		1817 00 21



straight male  
BSPT equal/unequal adaptor

**1821** C1 C2 

C1	C2	Part No.
R1/8	R1/8	1821 10 10
R1/4	R1/8	1821 13 10
R1/4	R1/4	1821 13 13
R3/8	R1/4	1821 17 13
R3/8	R3/8	1821 17 17
R1/2	R3/8	1821 21 17
R1/2	R1/2	1821 21 21



tailpiece adaptor for rubber  
hose, male BSPT thread

**1823** ØD C 

ØD	C	Part No.
7	R1/8	1823 07 10
7	R1/4	1823 07 13
10	R1/4	1823 10 13
10	R3/8	1823 10 17
13	R3/8	1823 13 17
16	R1/2	1823 16 21



internal hexagon headed,  
BSPT thread

**0285** C 

C	Part No.
R1/8	0285 10 00
R1/4	0285 13 00
R3/8	0285 17 00
R1/2	0285 21 00
R3/4	0285 27 00



threaded silencer,  
BSPP thread

**0682** C 

C	Part No.
G1/8	0682 00 10
G1/4	0682 00 13
G3/8	0682 00 17
G1/2	0682 00 21
G3/4	0682 00 27



reducer male BSPT to female  
BSPP thread

**1863** C1 C2 

C1	C2	Part No.
R1/4	G1/8	1863 13 10
R3/8	G1/8	1863 17 10
R3/8	G1/4	1863 17 13
R1/2	G1/4	1863 21 13
R1/2	G3/8	1863 21 17



# Stainless Steel Compression Fittings

male stud coupling,  
BSPT thread

**1805** ØD C 

ØD	C	Part No.
6	R1/8	1805 06 10
6	R1/4	1805 06 13
8	R1/8	1805 08 10
8	R1/4	1805 08 13
10	R1/4	1805 10 13
10	R3/8	1805 10 17
10	R1/2	1805 10 21
12	R1/4	1805 12 13
12	R3/8	1805 12 17
12	R1/2	1805 12 21
16	R3/8	1805 16 17
16	R1/2	1805 16 21



male stud elbow, BSPT thread

**1809** ØD C 

ØD	C	Part No.
6	R1/8	1809 06 10
6	R1/4	1809 06 13
8	R1/8	1809 08 10
8	R1/4	1809 08 13
10	R1/4	1809 10 13
10	R3/8	1809 10 17
10	R1/2	1809 10 21
12	R1/4	1809 12 13
12	R3/8	1809 12 17
12	R1/2	1809 12 21
16	R3/8	1809 16 17
16	R1/2	1809 16 21



straight stem adaptor,  
BSPT thread

**1820** ØD C 

ØD	C	Part No.
6	R1/8	1820 06 10
6	R1/4	1820 06 13
8	R1/8	1820 08 10
8	R1/4	1820 08 13
10	R1/4	1820 10 13
10	R3/8	1820 10 17
10	R1/2	1820 10 21
12	R1/4	1820 12 13
12	R3/8	1820 12 17
12	R1/2	1820 12 21
16	R3/8	1820 16 17
16	R1/2	1820 16 21



equal connector

**1806** ØD 

ØD	Part No.
6	1806 06 00
8	1806 08 00
10	1806 10 00
12	1806 12 00
16	1806 16 00







# Technical Tubes and Hoses

## Applications





The extensive compatibility of Legris fittings/technical tubes and hoses is ideally suited for **many industrial and food applications**. Legris' policy is to be able to offer its customers a **full range** of tubes and hoses, compatible with the different ranges of fittings featured in this product guide.

The overview below illustrates the **best choices** to obtain the **best performance** of the fitting/tube connection.



## 1025P-1100P Nylon Tubing

	connections	applications
<b>semi-rigid</b> 	LF 3000®, LF 3600, LF 3800 <b>instant fittings</b> 	pneumatic systems 
	<b>adaptors</b> 	
<b>benefits :</b> <ul style="list-style-type: none"> <li>- large range of working temperatures and pressures</li> <li>- good chemical resistance</li> <li>- 7 colours for easy identification of circuits</li> <li>- close tolerance, 3 mm to 16 mm</li> </ul>		





## 1025U-1100U Polyurethane Tubing

	connections	applications
<b>polyester</b> 	LF 3000®, LF 3600, LF 3800 <b>instant fittings</b> 	pneumatic systems 
	<b>adaptors</b> 	
<b>benefits :</b> <ul style="list-style-type: none"> <li>- large range of working temperatures and pressures</li> <li>- high flexibility</li> <li>- good chemical resistance</li> <li>- 7 colours for easy identification of circuits</li> <li>- close tolerance, 4 mm to 14 mm</li> </ul>		



## 1005T-1025T Fluoropolymer FEP Tube

	connections	applications
	LF 3600, LF 3800 <b>instant fittings</b> 	food industry and aggressive environment 
<b>benefits :</b> <ul style="list-style-type: none"> <li>- excellent resistance to chemicals and high temperature</li> <li>- FDA food quality</li> <li>- close tolerance, 4 mm to 12 mm</li> </ul>		



## 1470U-1471U-1472U Recoil Tubing

	connections	applications
<b>polyurethane</b> with integral 1/4" BSP taper fitting 	C 9000 and metal <b>quick acting couplers</b>  <b>Blowguns</b> 	pneumatic equipment 
<b>benefits :</b> <ul style="list-style-type: none"> <li>- the coil will continue to contract after multiple use</li> <li>- high flexibility</li> <li>- good chemical resistance</li> <li>- 3 colours</li> <li>- 4 mm to 12 mm o.d.</li> </ul>		

## 1100Y Polyethylene Tubing

	connections	applications
	LF 3600 <b>instant fittings</b> 	food and industrial applications 
<b>benefits :</b> <ul style="list-style-type: none"> <li>- good resistance to aggressive and corrosive agents</li> <li>- FDA food quality</li> <li>- 4 mm to 14 mm o.d.</li> </ul>		

## 1025V Braided PVC Hose

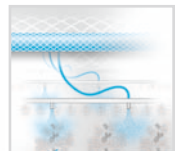
	connections	applications
	<b>adaptors</b>  C 9000 and metal <b>quick acting couplers</b> 	suitable for use with food and industrial fluids 
<b>benefits :</b> <ul style="list-style-type: none"> <li>- translucent for visual checking of fluid</li> <li>- FDA food quality</li> <li>- 8 mm to 26 mm o.d.</li> </ul>		



# Technical Tubes and Hoses

## Close tolerance semi-rigid nylon tubing

### 1025P-1100P close tolerance semi-rigid nylon tubing, 25 m and 100 m rolls

Length (m)	o.d. tube mm	i.d. tube mm	minimum bend radius for tube at ambient temp. in mm			
				1025P04 00 27	1025P04 01 27	1025P04 04 27
25	4	2,7	30			
25	6	4	35	1025P06 00	1025P06 01	1025P06 04
25	8	6	55	1025P08 00	1025P08 01	1025P08 04
25	10	7,5	75	1025P10 00 75	1025P10 01 75	1025P10 04 75
25	12	9	75	1025P12 00 09	1025P12 01 09	1025P12 04 09
25	14	11	100	1025P14 00 11	1025P14 01 11	1025P14 04 11
100	4	2,7	30	1100P04 00 27	1100P04 01 27	1100P04 04 27
100	6	4	35	1100P06 00	1100P06 01	1100P06 04
100	8	6	55	1100P08 00	1100P08 01	1100P08 04
100	10	7,5	75	1100P10 00 75	1100P10 01 75	1100P10 04 75

## Close tolerance flexible polyurethane tubing

### 1025U-1100U Close tolerance flexible polyurethane tubing, 25 m and 100 m rolls

Length (m)	o.d. tube mm	i.d. tube mm	minimum bend radius for tube at ambient temp. in mm				
			polyester	polyether	polyester	polyester	polyether
			1025U04 01	1025U04 04	1025U04 R08		
25	4	2,5	10	10			
25	6	4	15	20	1025U06 01	1025U06 04	1025U06R08
25	8	5,5	20	25	1025U08 01	1025U08 04	1025U08R08
25	10	7	25	35	1025U10 01	1025U10 04	1025U10R08
25	12	8	35	40	1025U12 01	1025U12 04	1025U12R08
25	14	9,5	45	50	1025U14 01 95	1025U14 04 95	1025U14R08 95
100	4	2,5	10	10	1100U04 01	1100U04 04	1100U04R08
100	6	4	15	20	1100U06 01	1100U06 04	1100U06R08
100	8	5,5	20	25	1100U08 01	1100U08 04	1100U08R08

## Close tolerance fluoropolymer FEP tube

### 1005T - 1025T

o.d. tube mm	i.d. tube mm	R minimum bend radius for tube at ambient temp. in mm		
			in 5 m rolls white	in 25 m rolls white
4	2,5	40	1005T04 00 25	1025T04 00 25
6	4	50	1005T06 00	1025T06 00
8	6	70	1005T08 00	1025T08 00
10	8	120	1005T10 00	1025T10 00
12	10	180	1005T12 00	1025T12 00

## Polyethylene tubing





### 1100Y Polyethylene tubing, 100 m rolls





o.d. tube mm	i.d. tube mm	R minimum bend radius for tube at 20° C (in mm)		
			in 100 m rolls	
4	2	25	1100Y04 00	
6	4	35	1100Y06 00	
8	6	55	1100Y08 00	
10	8	80	1100Y10 00	
12	9	65	1100Y12 00	
14	11	80	1100Y14 00	





 = suitable for food applications

# Technical Tubes and Hoses

## Close tolerance polyurethane recoil tubing





1470U polyurethane recoil tubing, 2 m long, with BSPT thread connections									
o.d. tube mm	i.d. tube mm	BSPT thread					length of long straight section in mm	length of short straight section in mm	
8	5	R1/4	<a href="#">1470U08 03 13</a>	<a href="#">1470U08 04 13</a>	<a href="#">1470U08 05 13</a>	190	500	100	42

1471U polyurethane recoil tubing, 4 m long, with BSPT thread connections									
o.d. tube mm	i.d. tube mm	BSPT thread					length of long straight section in mm	length of short straight section in mm	
8	5	R1/4	<a href="#">1471U08 03 13</a>	<a href="#">1471U08 04 13</a>	<a href="#">1471U08 05 13</a>	400	500	100	42

1472U polyurethane recoil tubing, 6 m long, with BSPT thread connections									
o.d. tube mm	i.d. tube mm	BSPT thread					length of long straight section in mm	length of short straight section in mm	
8	5	R1/4	<a href="#">1472U08 03 13</a>	<a href="#">1472U08 04 13</a>	<a href="#">1472U08 05 13</a>	650	500	100	42



## Braided PVC hose

 = suitable for food applications

1025V				in 25 m rolls white
o.d. tube mm	i.d. tube mm	R minimum bend radius for tube at ambient temp. in mm		
11	6	12		<a href="#">1025V11 00 06</a>
14	8	16		<a href="#">1025V14 00 08</a>
16	10	25		<a href="#">1025V16 00 10</a>

## Accessories

ferrule for plastic and fluoropolymer tubing

1827	Ø tube	Ø D2	
	6	4	<a href="#">1827 06 00</a>
	8	6	<a href="#">1827 08 00</a>
	10	8	<a href="#">1827 10 00</a>
	12	10	<a href="#">1827 12 00</a>
	16	14	<a href="#">1827 16 00</a>

ØD2

This ferrule is necessary when using fluoropolymer FEP tubing at all temperatures compatible with the fitting/tube assembly.

tube cutter

3000 71 00	
	<a href="#">3000 71 00</a>

This tool will cut all resilient plastic tube (nylon, FEP, polyurethane, braided PVC) from 4mm to 14mm diameter inclusive. It is designed to give a clean cut at right angles to the tube axis. A spring maintains the cutter in the closed position.

clip for PVC braided tube

0697	ØD	
	8	<a href="#">0697 00 01</a>
	10	<a href="#">0697 00 02</a>
	11	<a href="#">0697 00 02</a>
	13	<a href="#">0697 00 02</a>
	15	<a href="#">0697 00 03</a>
	18	<a href="#">0697 00 03</a>
	21	<a href="#">0697 00 04</a>
	26	<a href="#">0697 00 05</a>

# C9000 Quick-Acting Couplers

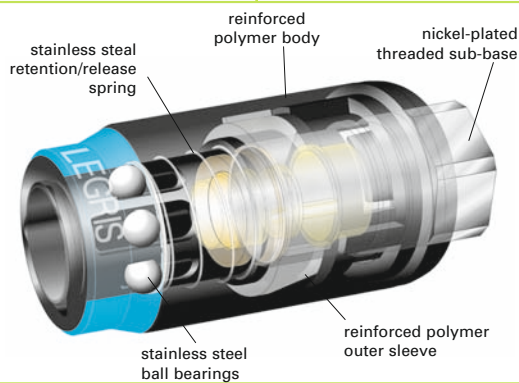
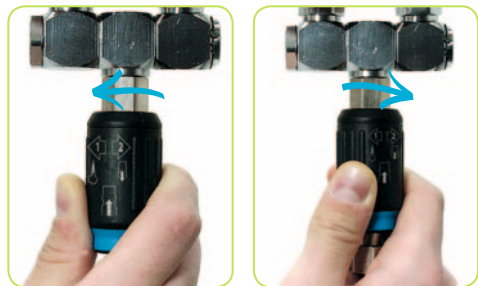

## Applications

- Industrial
- Industrial automation

## Benefits

### Polymer C 9000 quick acting safety couplers

- **100% safety** : even if disconnection is performed rapidly, the safety of the end-users is guaranteed thanks to a very short vent-time. Comply with **ISO 4414** and **EN 983** safety standards.
- very high **flow** and extremely small pressure loss
- perfectly controlled **sealing**
- **high impact** composite material **resistant** to shocks and scratching
- excellent **mechanical strength** : extending lifetime performance and reliability
- virtually **effortless** connection and disconnection

## Technical specifications

### Polymer C 9000 quick acting safety couplers

- suitable fluid** : compressed air
- working pressure** : 0 to 16 bar
- working temperature** : - 20° to + 60°C

# Blowguns



## Applications

- Industrial
- Industrial automation
- Transportation

## Benefits

- **Quality and performance**
  - Gradual and accurate control
  - Progressive and directional air jet up to 6 bar
  - Durable: impact resistant materials, high quality structure and finish
  - Rigorously tested and approved: seals and flow levels for all Legris blowguns are 100% tested
- **Handling and comfort**
  - Lower or upper connection points for secure gripping and distortion-free handling
  - Numerous hanging points, for easy and quick removal
- **Versatility**
  - Integrated pre-assembled standard nozzle ready for use
  - Can be used with a wide range of M12 x 1.25 threaded interchangeable nozzles

## Technical specifications

- Suitable fluid**: compressed air
- Maximum working pressure**: 10 bar
- Working temperature**: -15°C to +50°C
- Lower and upper connection points** : G1/4
- Interchangeable nozzle** : M12x1,25

### Materials

- Body** : nylon 6.6 30% glass fibre
- Seal** : nitrile
- Nozzle** :
  - nickel-plated brass (progressive control and safety versions)
  - aluminium (standard version)
- Pin** : nickel-plated brass



# C9000 Advanced Quick-Acting Safety Couplers

**Series ISO B6**  
Flow : 1250 NI/min  
Passage : 5,5 mm

male body, BSPP thread

**9401U** C 

G1/4	9401U06 13
G3/8	9401U06 17
G1/2	9401U06 21



male body, BSPT thread

**9405U** C 

R1/4	9405U06 13
R3/8	9405U06 17
R1/2	9405U06 21



female body, BSPP thread

**9414U** C 

G1/4	9414U06 13
G3/8	9414U06 17
G1/2	9414U06 21



body with hosetail

**9421U** ØD 

6	9421U06 06
8	9421U06 08
10	9421U06 10



**Series ISO B8**  
Flow : 2400 NI/min  
Passage : 8 mm

male body, BSPP thread

**9401U** C 

G1/4	9401U08 13
G3/8	9401U08 17
G1/2	9401U08 21



male body, BSPT thread

**9405U** C 

R1/4	9405U08 13
R3/8	9405U08 17
R1/2	9405U08 21



female body, BSPP thread

**9414U** C 

G1/4	9414U08 13
G3/8	9414U08 17
G1/2	9414U08 21



body with hosetail

**9421U** ØD 

6	9421U08 08
8	9421U08 08
10	9421U08 10



**Series Euro**  
Flow : 2000 NI/min  
Passage : 7,2 mm

male body, BSPP thread

**9401E** C 

G1/4	9401E07 13
G3/8	9401E07 17
G1/2	9401E07 21



female body, BSPT thread

**9414E** C 

G1/4	9414E07 13
G1/2	9414E07 21



body with hosetail

**9421E** ØD 

10	9421E07 10
13	9421E07 13



**Series ARO**  
Flow : 1250 NI/min  
Passage : 5,5 mm

male body, BSPP thread

**9401A** C 

G1/4	9401A06 13
G1/2	9401A06 21



male body, BSPT thread

**9405A** C 

R1/2	9405A06 21
------	------------



female body, BSPP thread

**9414A** C 

G3/8	9414A06 17
------	------------



body with hosetail

**9421A** ØD 

8	9410A06 08
---	------------



Large choice  
of nozzles available  
on our website :

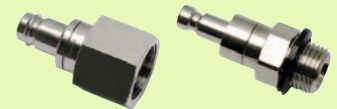

## Blowguns

**progressive control  
blowguns**

with short angled nozzle

C 

G1/4	0656 66 13
G1/4	0657 66 13



with standard nozzle

C 

G1/4	0651 66 13
G1/4	0658 66 13



threaded versions

C 

G1/4	0652 66 13
G1/4	0655 66 13



**safety blowgun**

C 

G1/4	0654 00 13
------	------------



**standard blowgun with  
fixed nozzle**

C 

G1/4	0659 00 13
------	------------



# Industrial Ball Valves and Axial Valves



## Applications

- Industrial
- Industrial automation
- Fluid and process control

## Benefits

- Wide range of ball valves : different types of technologies, various shapes and functions, large choice of materials, fluids...
- Large choice of nominal o.d. : 4 to 100 mm
- High resistance to high pressures and temperatures
- Long life products

**Nickel-plated brass ball valves**  
**Fluoropolymer series**

## Nickel-Plated Brass Ball Valves

**standard in-line ball valves**  
double female

**0402**

C	DN	
G1/8	4	0402 04 10
G1/	7	0402 07 10
G1/4	7	0402 07 13
G3/8	10	0402 10 17
G1/2	13	0402 13 21
G3/4	20	0402 20 27

Working temperature : -20° to +80°C  
Maximum allowable working pressure: 40 bar

**fluoropolymer series**  
double female

**4902**

C	DN	PN	
G1/4	10	30	4902 10 13
G3/8	10	30	4902 10 17
G1/2	15	30	4902 15 21
G3/4	20	30	4902 20 27
G1"	25	30	4902 25 34
G1"1/4	32	25	4902 32 42
G1"1/2	40	25	4902 40 49
G2"	50	25	4902 50 48

Working temperature : -20° to +130°C  
Maximum allowable working pressure: 30 bar

**lockable ball valves**  
double female with vent

**0439**

C	DN	
G1/4	7	0439 07 13
G3/8	10	0439 10 17
G1/2	13	0439 13 21

Working temperature : -20° to +80°C  
Maximum allowable working pressure: 40 bar  
handle is non-removeable.

## Light Series Ball Valve

double female

**0492**

C	DN	
G1/4	4	0492 04 13
G1/4	4	0492 04 13 64
G3/8	7	0492 07 17
G1/2	10	0492 10 21
G3/4	13	0492 13 27

Working temperature : -20° to +80°C  
Maximum allowable working pressure: 12 bar

male and female

**0491**

C	DN	
G1/4	4	0491 04 13
G1/4	4	0491 04 13 64
G3/8	7	0491 07 17
G1/2	10	0491 10 21
G3/4	13	0491 13 27

Working temperature : -20° to +80°C  
Maximum allowable working pressure: 12 bar

## Stainless Steel Ball Valves

double female, economy version,  
BSPP thread

**4810**

C	DN	PN	
G1/4	8	64	4810 08 13
G3/8	10	64	4810 10 17
G1/2	15	64	4810 15 21
G3/4	20	40	4810 20 27
G1"	25	40	4810 25 34

Threads conform to ISO 228-1.  
Working temperature : -20° to +150°C  
Maximum allowable working pressure: 64 bar

## Axial Valves

normally closed, double female,  
BSPP thread

**4202**

C	DN	
G3/8	10	4202 10 17 20
G1/2	15	4202 15 21 20
G3/4	20	4202 20 27 20
G1"	25	4202 25 34 20
G1"1/4	32*	4202 32 42 20*
G1"1/2	40*	4202 40 49 20*
G2"	50*	4202 50 48 20*

\* pilot port : 1/8" BSP parallel  
complete with M5 silencer  
Working temperature : -20° to +135°C  
Maximum working pressure : 10 bar

normally open, double female,  
BSPP thread

**4212**

C	DN	
G3/8	10	4212 10 17 20
G1/2	15	4212 15 21 20
G3/4	20	4212 20 27 20
G1"	25	4212 25 34 20
G1"1/4	32	4212 32 42 20*
G1"1/2	40	4212 40 49 20*
G2"	50	4212 50 48 20*

\* Pilot fluid : filtered compressed air  
Pilot pressure :  
- NC and NO : 4,2 to 8 bar  
- double acting : 3 to 8 bar

subbase for solenoid valve

**4298**

C	
M5x0,8	4298 00 01



# Parker Worldwide

**AE – UAE, Dubai**  
Tel: +971 4 8127100  
parker.me@parker.com

**AR – Argentina, Buenos Aires**  
Tel: +54 3327 44 4129

**AT – Austria, Wiener Neustadt**  
Tel: +43 (0)2622 23501-0  
parker.austria@parker.com

**AT – Eastern Europe, Wiener Neustadt**  
Tel: +43 (0)2622 23501 900  
parker.easteurope@parker.com

**AU – Australia, Castle Hill**  
Tel: +61 (0)2-9634 7777

**AZ – Azerbaijan, Baku**  
Tel: +994 50 2233 458  
parker.azerbaijan@parker.com

**BE/LU – Belgium, Nivelles**  
Tel: +32 (0)67 280 900  
parker.belgium@parker.com

**BR – Brazil, Cachoeirinha RS**  
Tel: +55 51 3470 9144

**BY – Belarus, Minsk**  
Tel: +375 17 209 9399  
parker.belarus@parker.com

**CA – Canada, Milton, Ontario**  
Tel: +1 905 693 3000

**CH – Switzerland, Etoy**  
Tel: +41 (0) 21 821 02 30  
parker.switzerland@parker.com

**CL – Chile, Santiago**  
Tel: +56 2 623 1216

**CN – China, Shanghai**  
Tel: +86 21 2899 5000

**CZ – Czech Republic, Klecany**  
Tel: +420 284 083 111  
parker.czechrepublic@parker.com

**DE – Germany, Kaarst**  
Tel: +49 (0)2131 4016 0  
parker.germany@parker.com

**DK – Denmark, Ballerup**  
Tel: +45 43 56 04 00  
parker.denmark@parker.com

**ES – Spain, Madrid**  
Tel: +34 902 330 001  
parker.spain@parker.com

**FI – Finland, Vantaa**  
Tel: +358 (0)20 753 2500  
parker.finland@parker.com

**FR – France, Contamine s/Arve**  
Tel: +33 (0)4 50 25 80 25  
parker.france@parker.com

**GR – Greece, Athens**  
Tel: +30 210 933 6450  
parker.greece@parker.com

**HK – Hong Kong**  
Tel: +852 2428 8008

**HU – Hungary, Budapest**  
Tel: +36 1 220 4155  
parker.hungary@parker.com

**IE – Ireland, Dublin**  
Tel: +353 (0)1 466 6370  
parker.ireland@parker.com

**IN – India, Mumbai**  
Tel: +91 22 6513 7081-85

**IT – Italy, Corsico (MI)**  
Tel: +39 02 45 19 21  
parker.italy@parker.com

**JP – Japan, Tokyo**  
Tel: +(81) 3 6408 3901

**KR – South Korea, Seoul**  
Tel: +82 2 559 0400

**KZ – Kazakhstan, Almaty**  
Tel: +7 7272 505 800  
parker.easteurope@parker.com

**LV – Latvia, Riga**  
Tel: +371 6 745 2601  
parker.latvia@parker.com

**MX – Mexico, Apodaca**  
Tel: +52 81 8156 6000

**MY – Malaysia, Shah Alam**  
Tel: +60 3 7849 0800

**NL – The Netherlands, Oldenzaal**  
Tel: +31 (0)541 585 000  
parker.nl@parker.com

**NO – Norway, Ski**  
Tel: +47 64 91 10 00  
parker.norway@parker.com

**NZ – New Zealand, Mt Wellington**  
Tel: +64 9 574 1744

**PL – Poland, Warsaw**  
Tel: +48 (0)22 573 24 00  
parker.poland@parker.com

**PT – Portugal, Leca da Palmeira**  
Tel: +351 22 999 7360  
parker.portugal@parker.com

**RO – Romania, Bucharest**  
Tel: +40 21 252 1382  
parker.romania@parker.com

**RU – Russia, Moscow**  
Tel: +7 495 645-2156  
parker.russia@parker.com

**SE – Sweden, Spånga**  
Tel: +46 (0)8 59 79 50 00  
parker.sweden@parker.com

**SG – Singapore**  
Tel: +65 6887 6300

**SK – Slovakia, Banská Bystrica**  
Tel: +421 484 162 252  
parker.slovakia@parker.com

**SL – Slovenia, Novo Mesto**  
Tel: +386 7 337 6650  
parker.slovenia@parker.com

**TH – Thailand, Bangkok**  
Tel: +662 717 8140

**TR – Turkey, Istanbul**  
Tel: +90 216 4997081  
parker.turkey@parker.com

**TW – Taiwan, Taipei**  
Tel: +886 2 2298 8987

**UA – Ukraine, Kiev**  
Tel: +380 44 494 2731  
parker.ukraine@parker.com

**UK – United Kingdom, Warwick**  
Tel: +44 (0)1926 317 878  
parker.uk@parker.com

**US – USA, Cleveland**  
Tel: +1 216 896 3000

**VE – Venezuela, Caracas**  
Tel: +58 212 238 5422

**ZA – South Africa, Kempton Park**  
Tel: +27 (0)11 961 0700  
parker.southafrica@parker.com



## Fluid System Connectors Europe

Legris SAS

Groupe Parker Hanifin

BP 70411

74 rue de Paris

35704 Rennes Cedex 7

Tel. : +33 2 99 25 55 00

Fax. : +33 2 99 25 55 99

www.legris.com