

IPVA High-pressure internal gear pumps Technical data sheet



Advantages

- + Very high overall efficiency
- + Very good pulsation behavior
- + Low noise emission
- + Multiple flow capable

Function

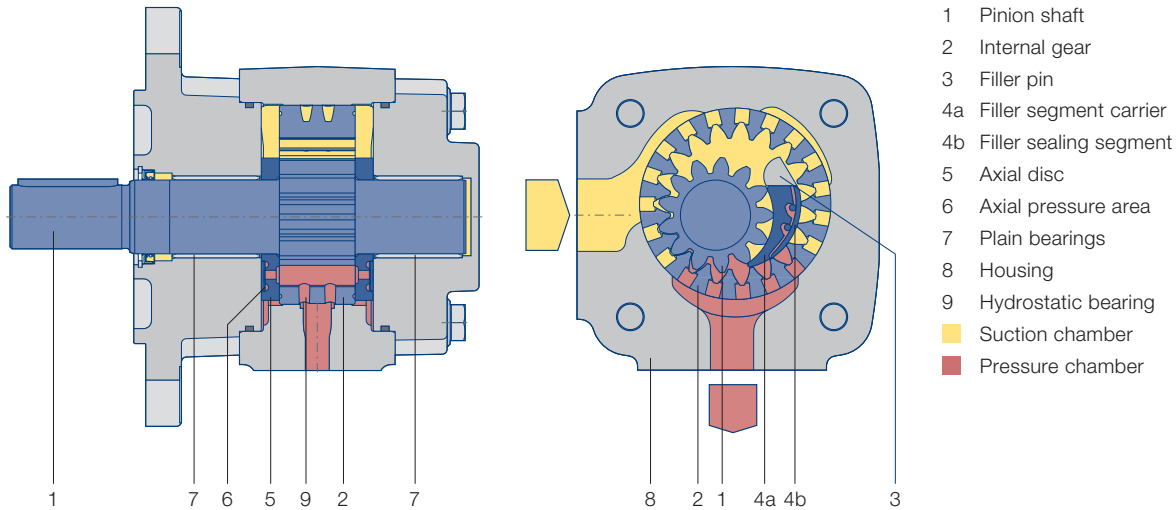

- 1 Pinion shaft
- 2 Internal gear
- 3 Filler pin
- 4a Filler segment carrier
- 4b Filler sealing segment
- 5 Axial disc
- 6 Axial pressure area
- 7 Plain bearings
- 8 Housing
- 9 Hydrostatic bearing
- Suction chamber
- Pressure chamber

By rotation of the gears inside the pump, the pressure fluid (usually hydraulic oil) is drawn into the cavity between the pinion and internal gear. Optimized cross-sectional areas on suction side as well as on pressure side allow operation over a wide range of speed.

In the radial direction, the gear chambers are closed by gear meshing and the filler piece. In the axial direction, the axial plates seal the pressure chamber with the minimal possible gap. This design minimizes volume losses and increases efficiency.

Calculations

Pump flow $Q = V_{g\text{th}} \cdot n \cdot \eta_v \cdot 10^{-3} \text{ [l/min]}$

Power $P = \frac{Q \cdot \Delta p}{600 \cdot \eta_g} \text{ [kW]}$

$V_{g\text{th}}$	pump volume per revolution [cm ³]
n	Speed [rpm]
η_v	Volumetric efficiency
η_g	Overall efficiency
Δp	Differential pressure [bar]

Technical data

Design	Internal gear pump with radial and axial sealing gap compensation
Type	IPVA
Mounting types	SAE hole flange; ISO 3019/1
Line mounting	SAE suction and pressure flange J 518 C Code 61
Sense of rotation	Right hand rotation
Mounting position	any
Shaft load	For details of radial and axial drive shaft loads please contact your J.M. Voith SE & Co. KG representative
Input pressure	0.8 ... 3 bar absolute pressure
Pressure fluid	HLP mineral oils DIN 51524, part 2 or 3
Viscosity range of the pressure fluid	10 ... 300 mm ² s ⁻¹ (cSt)
Permissible start viscosity	max. 2 000 mm ² s ⁻¹ (cSt)
Permissible temperature of the pressure fluid	-20 ... +80 °C
Required purity of the pressure fluid according to NAS 1638	Class 19/17/14 (ISO 4406), Class 8 (NAS 1638)
Filtration	Filtration quotient min. $\beta_{20} \geq 75$, recommended $\beta_{10} \geq 100$ (longer life)
Permissible ambient temperature	-20 ... +60 °C

Characteristics

Type, Size – delivery	Displacement per revolution [cm ³]	Speed min. [rpm]	Speed max. [rpm]	Delivery at 1500 rpm [l/min]	Continuous pressure [bar]	Peak pressure at 1 500 rpm [bar]	Moment of inertia [kg cm ²]
IPVA 3 – 3.5	3.6	400	3 600	5.4	300	320	0.34
IPVA 3 – 5	5.2	400	3 600	7.8	300	320	0.42
IPVA 3 – 6.3	6.4	400	3 600	9.6	300	320	0.49
IPVA 3 – 8	8.2	400	3 600	12.3	300	320	0.58
IPVA 3 – 10	10.2	400	3 600	15.3	300	320	0.70
IPVA 4 – 13	13.3	400	3 600	19.9	300	320	2.25
IPVA 4 – 16	15.8	400	3 400	23.7	300	320	2.64
IPVA 4 – 20	20.7	400	3 200	31.0	300	320	3.29
IPVA 4 – 25	25.4	400	3 000	38.1	300	320	3.70
IPVA 4 – 32	32.6	400	2 800	48.9	250	280	4.44
IPVA 5 – 32	33.1	400	3 000	49.6	300	320	8.62
IPVA 5 – 40	41.0	400	2 800	61.5	300	320	10.20
IPVA 5 – 50	50.3	400	2 500	75.4	280	315	11.60
IPVA 5 – 64	64.9	400	2 200	97.3	230	250	14.40
IPVA 6 – 64	64.1	400	2 600	96.1	300	320	25.73
IPVA 6 – 80	80.7	400	2 400	121.0	280	315	30.90
IPVA 6 – 100	101.3	400	2 100	151.9	250	300	36.10
IPVA 6 – 125	126.2	400	1 800	189.3	210	250	43.70

The values given apply for

- Pumping of mineral oils with a viscosity of 20...40 mm²s⁻¹
- An input pressure of 0.8 ... 3.0 bar absolute

Notes

- Peak pressures apply for 15 % of operating time with a maximum cycle time of 1 minute.
- Please inquire about peak pressures at non-standard speeds.
- Due to production tolerances, the pump volume may be reduced by up to 1.5 %.

IPVA 3, rotation and dimensions

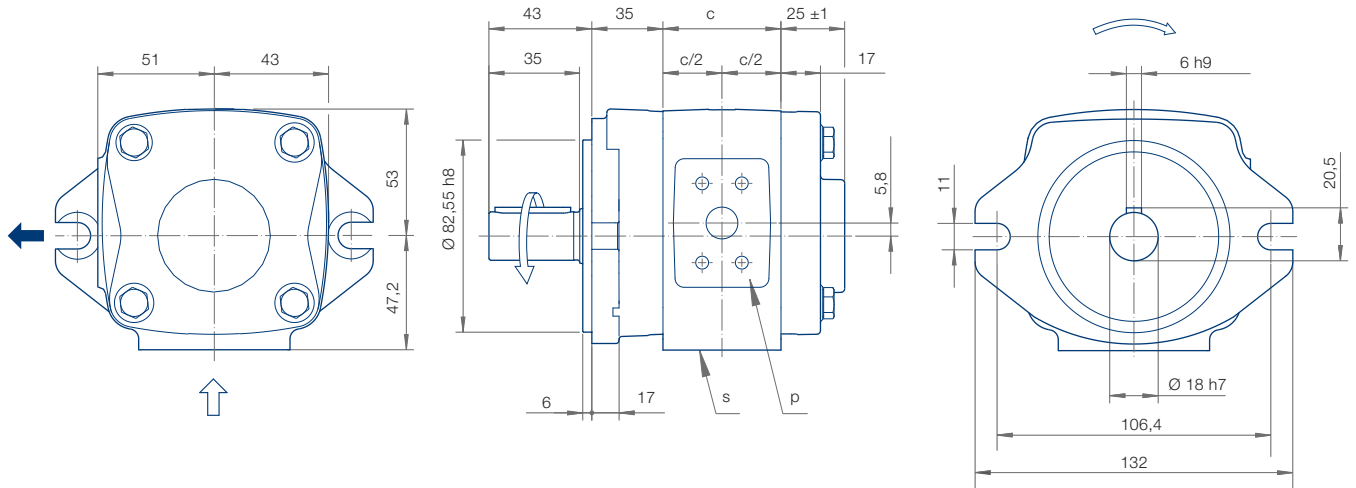

Pressure port (P)

Suction port (S)

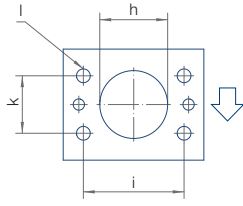
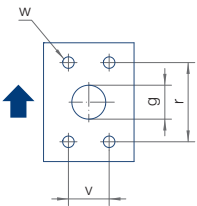

Type/ Delivery	c [mm]	g [mm]	h [mm]	i [mm]	k [mm]	l Thread	r [mm]	v [mm]	w Thread	Weight [kg]	SAE Flange No.	
IPVA 3 – 3.5	35	9	14	38.1	17.5	M8x13	38.1	17.5	M8x13	3.4	10	10
IPVA 3 – 5	39	11	14	38.1	17.5	M8x13	38.1	17.5	M8x13	3.6	10	10
IPVA 3 – 6.3	42	11	19	47.6	22.3	M10x15	38.1	17.5	M8x13	3.8	10	11
IPVA 3 – 8	46.5	13	19	47.6	22.3	M10x15	38.1	17.5	M8x13	4.0	10	11
IPVA 3 – 10	51.5	13	21	52.4	26.2	M10x15	38.1	17.5	M8x13	4.2	10	12

IPVA 3, design

Rotation

Mounting flange

Shaft end

Standard

Rotation clockwise



SAE 2-hole
flange

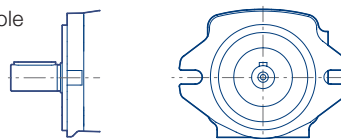

0

Parallel shaft
with keyway
connection

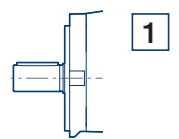

IPVA 4, rotation and dimensions

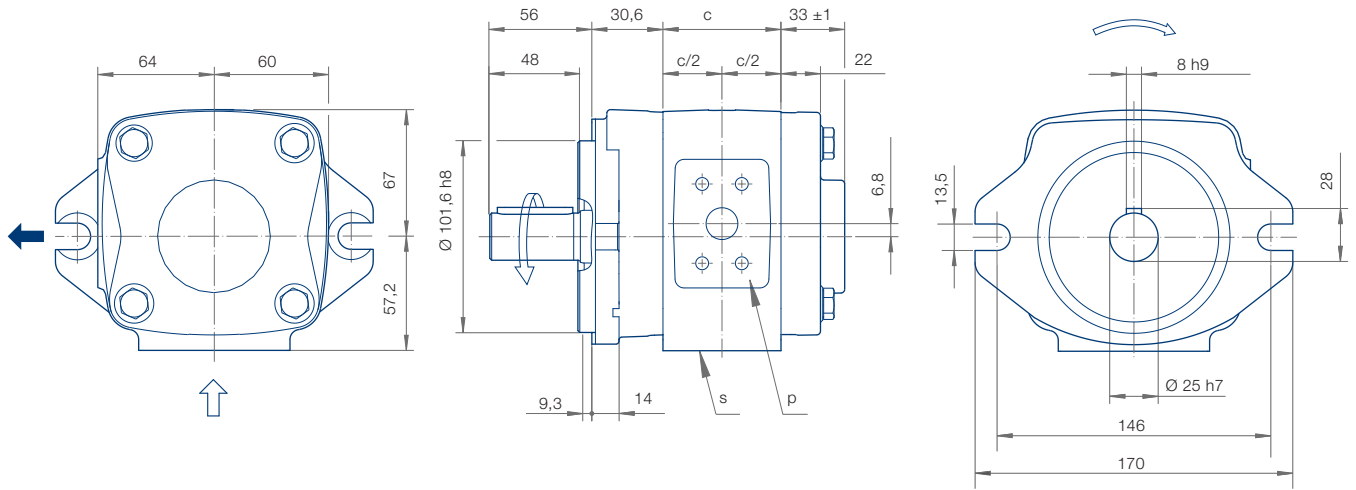

Pressure port (P)

Suction port (S)

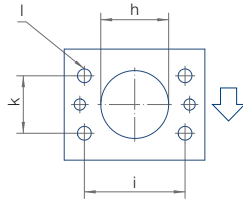
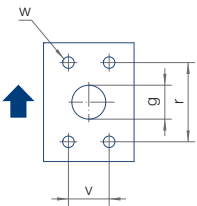

Type/ Delivery	c [mm]	g [mm]	h [mm]	i [mm]	k [mm]	l Thread	r [mm]	v [mm]	w Thread	Weight [kg]	SAE Flange No.	
IPVA 4 – 13	48.5	13	23	52.4	26.2	M10x15	38.1	17.5	M8x13	7.1	10	12
IPVA 4 – 16	52.5	14	25	52.4	26.2	M10x15	38.1	17.5	M8x13	7.3	10	12
IPVA 4 – 20	58	18	27	58.7	30.2	M10x15	47.6	22.3	M10x15	7.9	11	13
IPVA 4 – 25	64	18	30	58.7	30.2	M10x15	47.6	22.3	M10x15	8.3	11	13
IPVA 4 – 32	73	18	32	58.7	30.2	M10x15	47.6	22.3	M10x15	9.1	11	13

IPVA 4, design

Rotation

Mounting flange

Shaft end

Standard

Rotation clockwise



SAE 2-hole
flange

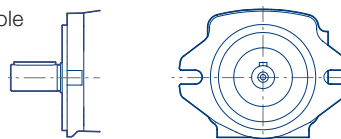

7

Parallel shaft
with keyway
connection

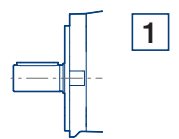

IPVA 6, rotation and dimensions

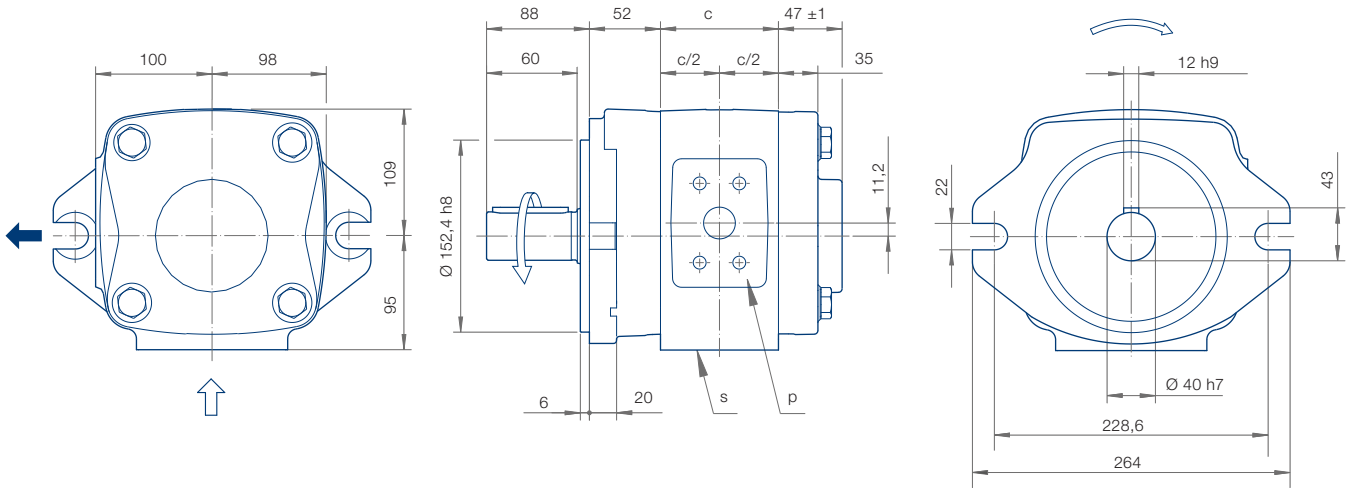

Pressure port (P)

Suction port (S)

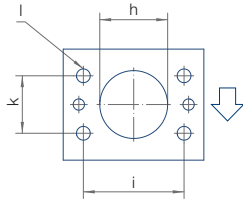
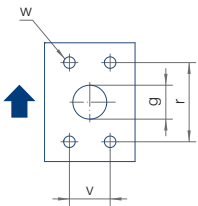

Type/ Delivery	c [mm]	g [mm]	h [mm]	i [mm]	k [mm]	l Thread	r [mm]	v [mm]	w Thread	Weight [kg]	SAE Flange No. ↑ ↓
IPVA 6 – 64	80	23	40	69.9	35.7	M12x20	52.4	26.2	M10x15	26.3	12 30
IPVA 6 – 80	88	23	45	77.8	42.9	M12x20	69.9	35.7	M12x20	27.9	14 15
IPVA 6 – 100	98	27	50	77.8	42.9	M12x20	69.9	35.7	M12x20	31.2	14 15
IPVA 6 – 125	110	30	50	77.8	42.9	M12x20	69.9	35.7	M12x20	34.0	14 15

IPVA 6, design

Rotation

Mounting flange

Shaft end

Standard

Rotation clockwise



SAE 2-hole flange

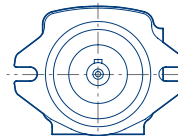
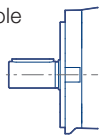

0

Parallel shaft
with keyway
connection

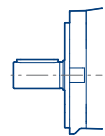

1

Measurement values – Airborne noise level (measuring location 1 m axial)

IPVA 3

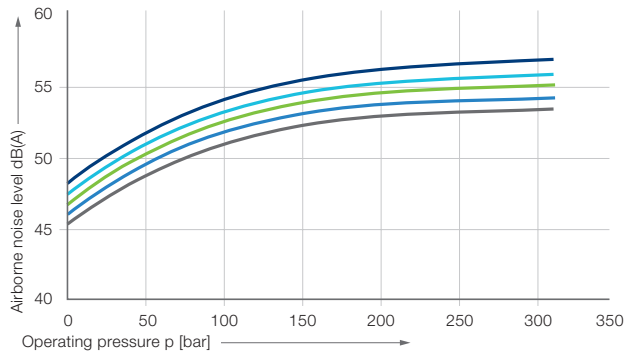

— IPVA 3 – 10 — IPVA 3 – 6.3 — IPVA 3 – 3.5
— IPVA 3 – 8 — IPVA 3 – 5

IPVA 4

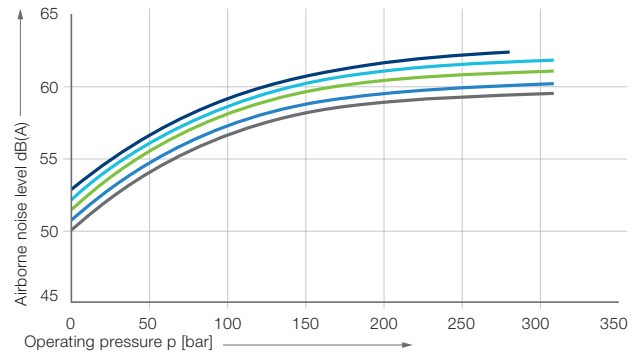

— IPVA 4 – 32 — IPVA 4 – 20 — IPVA 4 – 13
— IPVA 4 – 25 — IPVA 4 – 16

IPVA 5

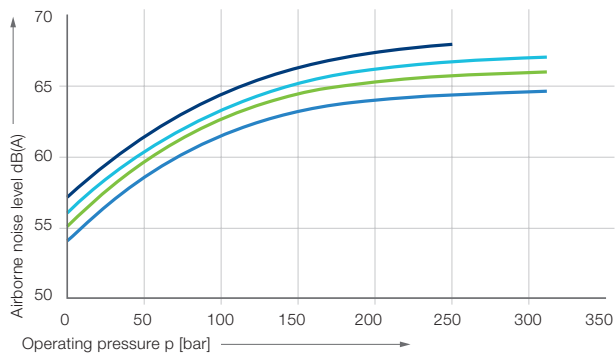

— IPVA 5 – 64 — IPVA 5 – 40
— IPVA 5 – 50 — IPVA 5 – 32

IPVA 6

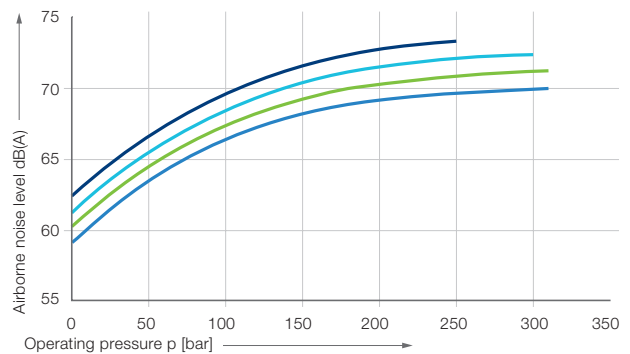

— IPVA 5 – 125 — IPVA 5 – 80
— IPVA 5 – 100 — IPVA 5 – 64

Measurement conditions

- Speed: 1500 rpm
- Viscosity of pressure fluid: 46 mm²s⁻¹
- Operating temperature: 40 °C

Note

Measurement taken in a low-noise room. In a anechoic room, the measurements are approx. 5 dB(A) lower.

Measurement values – Efficiency η_v and η_g

IPVA 3

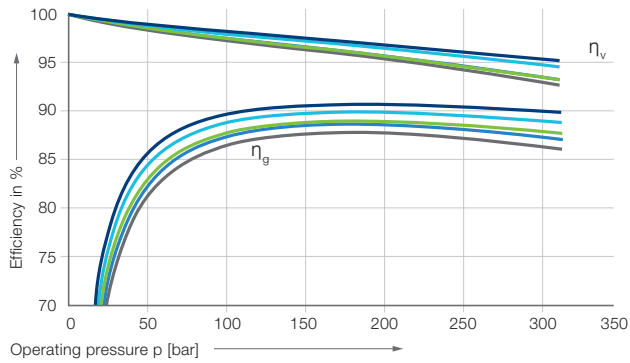

— IPVA 3 – 10 — IPVA 3 – 6.3 — IPVA 3 – 3.5
— IPVA 3 – 8 — IPVA 3 – 5

IPVA 4

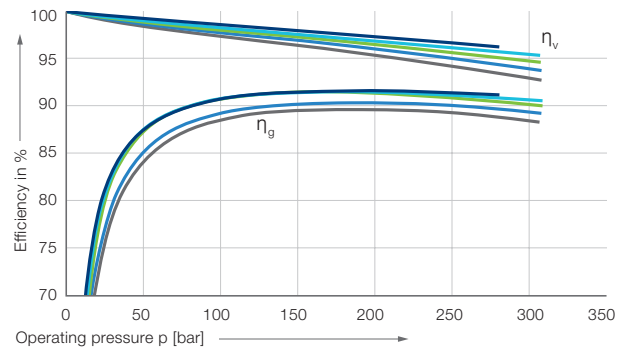

— IPVA 4 – 32 — IPVA 4 – 20 — IPVA 4 – 13
— IPVA 4 – 25 — IPVA 4 – 16

IPVA 5

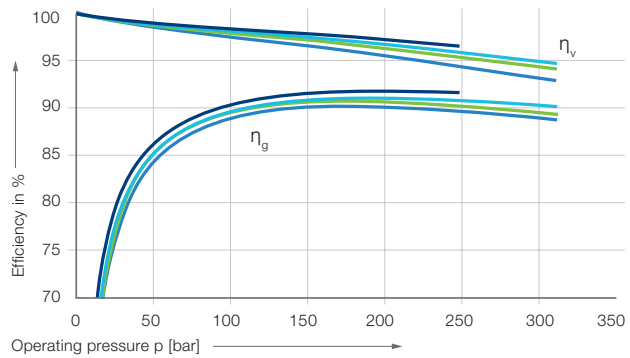

— IPVA 5 – 64 — IPVA 5 – 40
— IPVA 5 – 50 — IPVA 5 – 32

IPVA 6

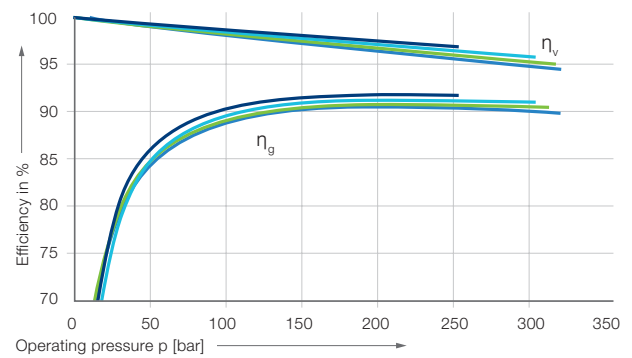

— IPVA 6 – 125 — IPVA 6 – 80
— IPVA 6 – 100 — IPVA 6 – 64

Measurement conditions

- Speed: 1500 rpm
- Viscosity of pressure fluid: 46 mm²s⁻¹
- Operating temperature: 40 °C

SAE-Flange, SAE J 518 C Code 61, single-piece

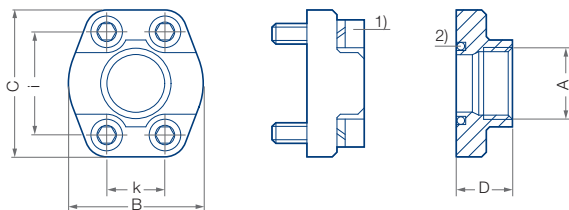

Wrench torque for screws according to ISO 6162

- 1) Round seal ring (O-Ring) ISO-R 1629 NBR
- 2) Screw EN ISO 4762
- 3) Special design, deviation from SAE J 518 C Code 61

SAE flange no.	A Thread	B [mm]	C [mm]	D [mm]	E ¹⁾ Seal ring	i [mm]	k [mm]	S ²⁾ Thread	max. pressure [bar]
10	G ½	46	54	36	18.66 – 3.53	38.1	17.5	M 8	345
11	G ¾	50	65	36	24.99 – 3.53	47.6	22.3	M10	345
12	G 1	55	70	38	32.92 – 3.53	52.4	26.2	M10	345
13	G 1-¼	68	79	41	37.69 – 3.53	58.7	30.2	M10	276
14 ³⁾	G 1-½	82	98	50	47.22 – 3.53	69.9	35.7	M12	345 ³⁾
30	G 1-½	78	93	45	47.22 – 3.53	69.9	35.7	M12	207
15	G 2	90	102	45	56.74 – 3.53	77.8	42.9	M12	207
16	G 2-½	105	114	50	69.44 – 3.53	88.9	50.8	M12	172
17	G 3	124	134	50	85.32 – 3.53	106.4	61.9	M16	138
18	G 4	146	162	48	110.72 – 3.53	130.2	77.8	M16	34

Multi-flow pumps, pump combinations, sequence in order of type and size

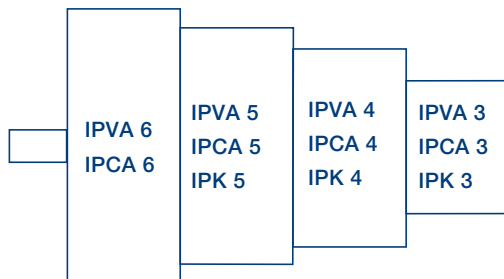

Pump combinations





- IPVA, IPCA, IPK pumps of identical or different sizes can be combined in multiflow pumps.
- All sizes of the relevant pump volume are available as two- or three-flow pumps; four-flow pumps must be designed by J.M. Voith SE & Co. KG
- The pumps are arranged in increasing order according to frame size and delivery.

Selection

1. Determine pressure ranges and define the appropriate pump serie(s)
2. Determine pump volume and select the appropriate size
3. Define sequence of the pumps
4. Check the torques

Mounting, assembly

Multi-flow pumps are generally mounted to the drive by means of a flange.

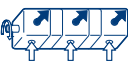
Rotation and suction	Mounting flange	Shaft end
clockwise (cw) 		
 1	0 SAE-2-hole-flange SAE-2-hole-flange (variant)	1
 1	7	
Special design 4		

Type code

IPVA 3-3.5 1 0 1

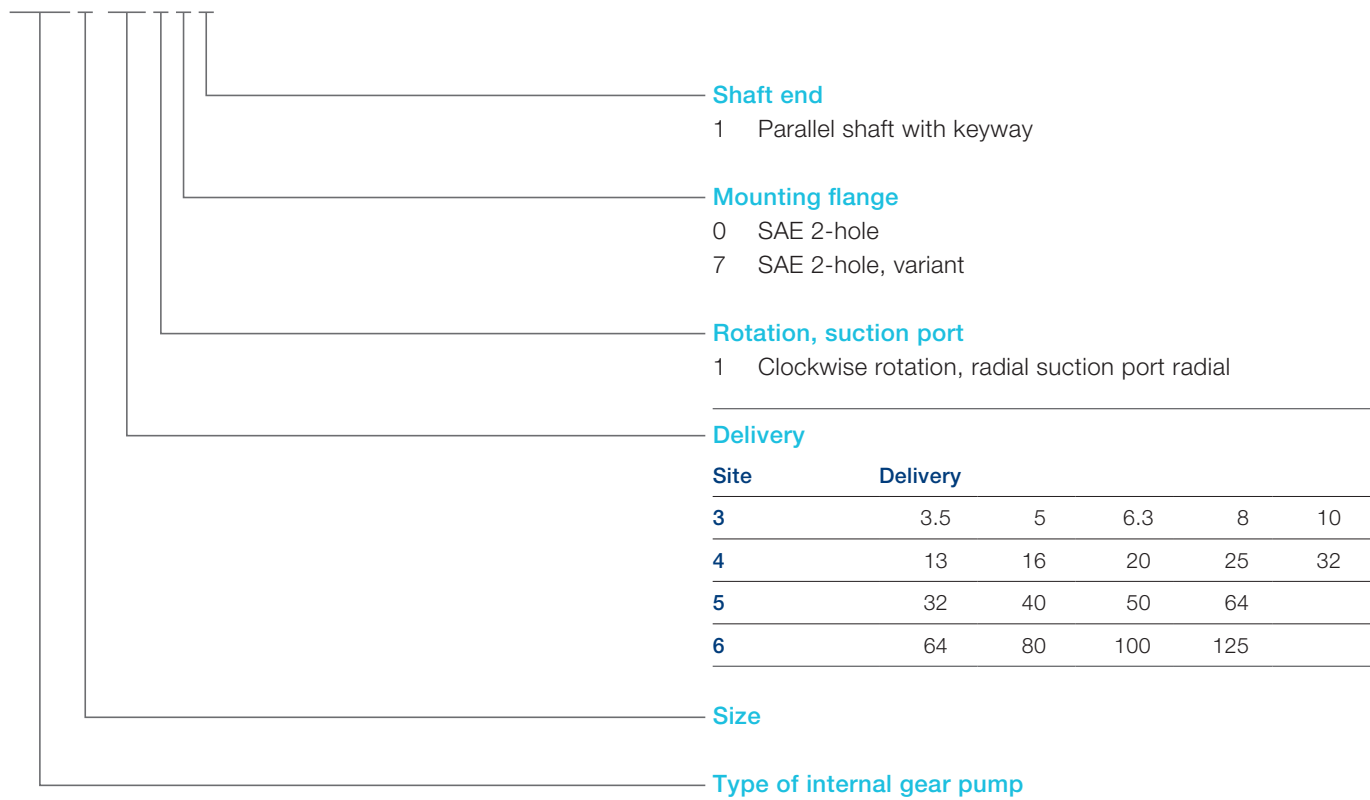

Type code for multiple flow capable variants

IPVA 4/ - 20/ 1 7 1



following multiple flow capable pump stage of the same size, freely selectable delivery volumes

IPVA 4/3 - 20/ 1 7 1



following multiple flow capable predetermined pump stage of the same or smaller size, freely selectable delivery volumes

This is a translated document
Original language: German
Legally binding language version of the document: German

Voith Group
St. Poeltener Str. 43
89522 Heidenheim
Germany

www.voith.com/hydraulic-systems

Contact:
Phone +49 7152 992 3
sales-rut@voith.com



VOITH

Inspiring Technology
for Generations