

Digital pressure sensor PPX Series



DIGITAL PRESSURE SENSOR PPX SERIES



Advanced pressure sensor!!



Operability is improved with dual display!

The product has been improved with 3 new functions.

NEW
1

Visibility improved

Digital display is now wider and easy to see.
Also, display pressure range and set pressure range are now wider too.



NEW
2

Analog current output is added to high function type

High function type with which analog voltage output, analog current output, or external input can be selected instead of single comparison output. It can be adopted in multi-use.

Switch between analog current and analog voltage

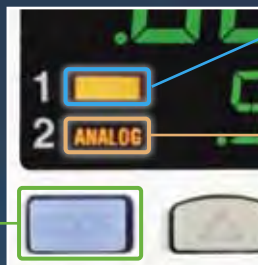

Selection

Comparison output

Analog voltage output

Low pressure type: 1 to 5V,
high pressure type: 0.6 to 5V

Analog current output

Low pressure type: 4 to 20mA,
high pressure type: 2.4 to 20mA

External input

Auto reference/
remote zero adjusting

NEW
3

Further reduction of power consumption

- Reduce 14% in normal operation compared with conventional models
- Reduce 30% to 50% in ECO MODE

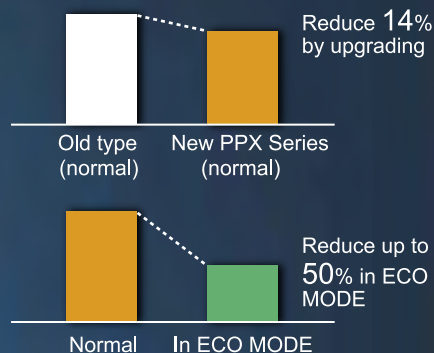

Digital pressure sensor

PPX Series

Direct setting with 2 screens

Comparison output 1 operational indicator light

Comparison output 2 operational indicator light
(High function type has analog voltage output operation indicator lights)

Mode switchover key

Current value [Main display]
3-color display (red, green, orange)
Color of main display part switches between green and red corresponding to on or off of output. It is orange during setting.

Set value [Sub display section]
Sub display part is customisable
Any alphanumerics other than set value can be displayed.

RUN MODE Setting adjustment and key lock, etc. are possible during operation.

Menu settings mode Basic settings including setting output mode, switching NO/NC are available.

PRO mode Advanced functions including copy function and sub display change are configurable.

Copy function which helps to reduce man-hour and prevent mistakes

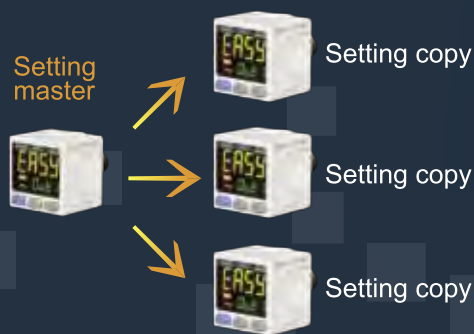

Equipped two independent outputs (standard type)

Equipped two independent comparison outputs and alternative detection mode can be selected for each.

3 types of detection modes can be selected

- EASY MODE...controls comparison output on or off
- Hysteresis mode...controls comparison output on or off by setting hysteresis
- Window comparator...controls comparison output on or off with pressure in the setting range

Enhanced output circuit

- Equipped reverse connection protection circuit on transistor output circuit

Easy to operate

- Readable alphanumeric display

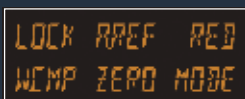

- Peak/bottom hold
It displays the maximum value and minimum value of variable pressure in two displays.
- Response time can be adjusted in 10 stages (2.5ms to 5000ms)
- Setting details can be displayed in code number



Space saving
Contact installation
is achievable.

Digital pressure sensor applications

● Positive pressure and vacuum confirmation or interlock

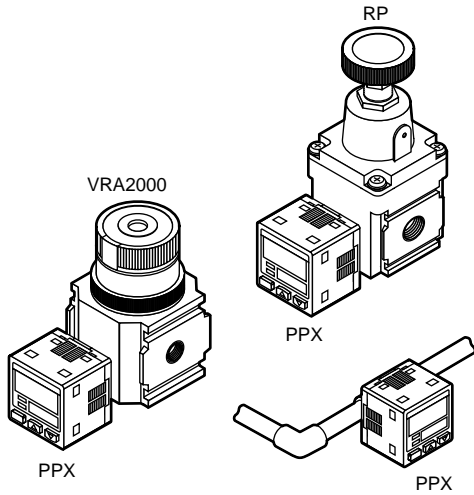

● High function type

- Easy setting with auto reference/remote zero adjusting

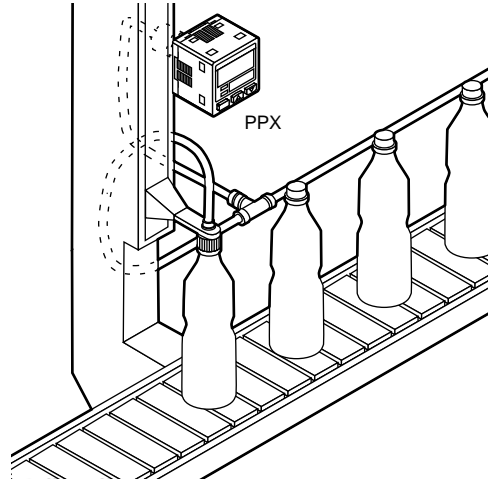

● Manifold

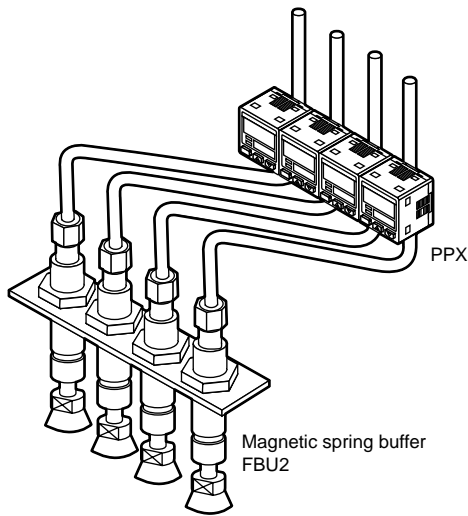

● Both vacuum pressure and burst pressure can be controlled with a single unit.

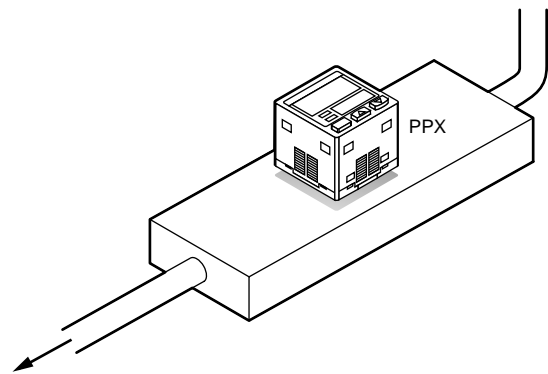

● Contact confirmation

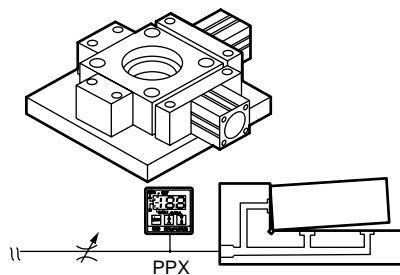

MEMO



Digital pressure sensor PPX Series

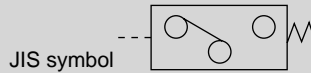

Specifications

Descriptions	Standard type		High function type	
	For low pressure PPX-R01*	For high pressure PPX-R10*	For low pressure PPX-R01*H	For high pressure PPX-R10*H
Kind of pressure	Gauge pressure			
Rated pressure	-100.0 to +100.0kPa	-0.100 to +1.000MPa	-100.0 to +100.0kPa	-0.100 to +1.000MPa
Set pressure	-101.0 to +101.0kPa	-0.101 to +1.010MPa	-101.0 to +101.0kPa	-0.101 to +1.010MPa
Proof pressure	500kPa	1.5MPa	500kPa	1.5MPa
Applicable fluid	Air/non-corrosive gas			
Power supply voltage	12 to 24VDC ±10% ripple P-P 10% or less			
Power consumption	Normal: 720mW or less (power consumption 30mA or less at 24V power supply voltage) ECO mode: 480mW or less at STD (power consumption 20mA or less at power supply voltage 24V), 360mW or less at FULL (power consumption 15mA or less at power supply voltage 24V)			
Comparison output (comparison output 1/ comparison output 2)	<NPN output type> NPN transistor/open collector • Max. inrush current: 100mA • Applied voltage: 30VDC or less (comparison output-0V interval) • Residual voltage: 2V or less (at inrush current 100mA)		<PNP output type> PNP transistor/open collector • Max. outflow current: 100mA • Applied voltage: 30VDC or less (comparison output between - and +) • Residual voltage: 2V or less (at output current 100mA)	
	Output operation	Select NO/NC with the key operation		
Output mode	EASY MODE/hysteresis mode/window comparator mode			
Hysteresis	Min.1 digit (variable)			
Repeatability	±0.1% F.S. (Within ±2 digits)	±0.2% F.S. (Within ±2 digits)	±0.1% F.S. (Within ±2 digits)	±0.2% F.S. (Within ±2 digits)
Response time	2.5ms, 5ms, 10ms, 25ms, 50ms, 100ms, 250ms, 500ms, 1000ms, 5000ms select by the key operation			
Short circuit protection	Equipped			
External input (auto reference/remote zero adjusting)	_____		<NPN output type> ON voltage: 0.4VDC or less OFF voltage: 5 to 30VDC or release Input impedance: approx. 10kΩ Input time: 1ms and over	<PNP output type> ON Voltage: 5V to +VDC OFF voltage: 0.6VDC or less or release Input impedance: approx. 10kΩ Input time: 1ms and over
Analog voltage output	_____		Output voltage: 1 to 5V Zero point: Within 3V ±5% F.S. Span: Within 4V ±5% F.S. Linearity: Within ±1% F.S. Output impedance: approx. 1kΩ	Output voltage: 0.6 to 5V Zero point: Within 1V ±5% F.S. Span: Within 4.4V ±5% F.S. Linearity: Within ±1% F.S. Output impedance: approx. 1kΩ
Analog current output	_____		Output current: 4 to 20mA Zero point: Within 12mA ±5% F.S. Span: Within 16mA ±5% F.S. Linearity: Within ±1% F.S. Load resistance: 250Ω (max.)	Output voltage: 2.4 to 20mA Zero point: Within 4mA ±5% F.S. Span: Within 17.6mA ±5% F.S. Linearity: Within ±1% F.S. Load resistance: 250Ω (max.)
Display	4-digit + 4-digit tri-color LCD display (display update cycle: 250ms, 500ms, 1000ms, select with key operations)			
Display pressure range	-101.0 to +101.0kPa	-0.101 to +1.010MPa	-101.0 to +101.0kPa	-0.101 to +1.010MPa
Indicator light	Orange LED (Comparison output 1 operational indicator light, comparison output 2 operational indicator light; comparison output ON lighting)		Orange LED (Comparison output 1 operational indicator light; comparison output ON lighting, analog voltage output operational indicator light; Lighting when setting)	
Environmental resistance	Degree of protection IP40 (IEC)			
	Ambient temperature -10 to + 50°C , at store: -10 to + 60°C			
	Ambient humidity 35 to 85% RH (no dew condensation, freezing), store: 35 to 85% RH			
	Withstand voltage 1000VAC for one minute applied to all charged sections/between cases			
	Insulation resistance 50MΩ and over with 500VDC mega applied to all charged sections/between cases			
	Vibration resistance Durability 10 to 500Hz double amplitude 3mm 2 hours each in XYZ directions (when mounted on panel: durability 10 to 150Hz double amplitude width 0.75mm 2 hours each in XYZ directions)			
Shock resistance Durability 100m/S ² (approx. 10 G) 3 times each in XYZ directions				
Temperature characteristics (+ 20°C reference)	Within ±0.5% F.S.	Within ±1% F.S.	Within ±0.5% F.S.	Within ±1% F.S.
Port size Note 1	M5 female thread + R (PT) 1/8 male thread			
Material	Case: PBT (with glass fiber), LCD display part: acrylic, pressure port: SUS303, mounting screw part: brass (nickel coat), switch part: silicon rubber			
Connection	Connector			
Wiring length	Up to 100m permissible with 0.3mm ² or larger cable (less than 30m when CE Mark-compliant)			
Unit change	Compatible only with export models (-KA) (MPa, kPa, kgf/cm ² , bar, psi, mmHg, inchHg)			
Weight	Product weight: approx. 40g, weight including package: 130g			
Accessory Note 2	PPX-C2 (2m cable with connector): 1 pc. Unit seal label (KA with unit change): MPa, kPa,kgf/cm ² , bar, psi, mmHg, inchHg			

Note 1: See Table 1 on the next page for export use.

Note 2: For (-J), connector cable is not attached.

How to order

<How to order for domestic market>

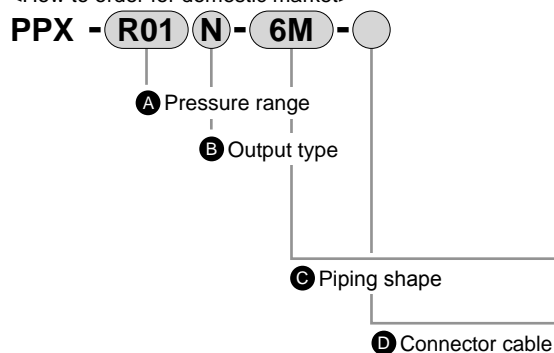

<How to order for foreign markets>

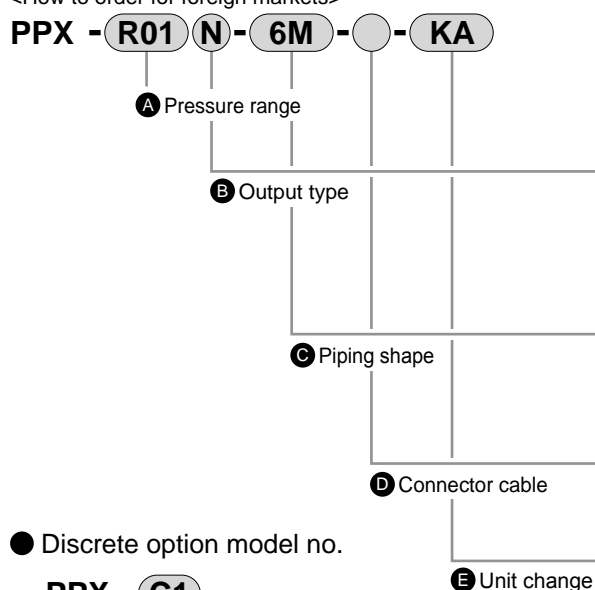

● Discrete option model no.

PPX - (C1)

Symbol	Descriptions
C1	Cable with connector 1m
C2	Cable with connector 2m
C3	Cable with connector 3m
C5	Cable with connector 5m
CN	Connector set (10 pcs. per set)
KL	Bracket (set screw attached)
KHS	Panel bracket
KCB	Front protective cover (when panel bracket used)

Symbol	Descriptions
A Pressure range	
R01	-100.0 to 100.0kPa
R10	-0.100 to 1.000MPa
B Output type	
N	NPN transistor output 2 point (standard type)
P	PNP transistor output 2 point (standard type)
NH	NPN transistor output 1 point + analog voltage/current output or external input (high function type)
PH	PNP transistor output 1 point + analog voltage/current output or external input (high function type)
C Piping shape	
6M	R1/8, M5 female thread
D Connector cable	
Blank	With 2m connector cable
J Note 1	Without connector cable

Note 1: It is available only if B output type "N" or "P" is selected.

With the new Measurement Law, the product with the unit change function for foreign markets cannot be used in Japan.

Symbol	Descriptions
A Pressure range	
R01	-100.0 to 100.0kPa
R10	-0.100 to 1.000MPa
B Output type	
N	NPN transistor output 2 point (standard type)
P	PNP transistor output 2 point (standard type)
NH	NPN transistor output 1 point + analog voltage/current output or external input (high function type)
PH	PNP transistor output 1 point + analog voltage/current output or external input (high function type)
C Piping shape	
6M Note 1	R1/8, M5 female thread
6N	NPT1/8, M5 female thread
6G Note 2	G1/8, M5 female thread
D Connector cable	
Blank	With 2m connector cable
J Note 3	Without connector cable
E Unit change	
KA	With unit change function

Note 1: B output type "N" or "NH" is only available.

Note 2: B output type "P" or "PH" is only available.

Note 3: It is available only if B output type "N" or "P" is selected.

Destination	Switch output		Unit	Unit change	Unit seal label to be attached Note 1	Piping port
	NPN	PNP				
Domestic	○	○	kPa/MPa	-	-	R1/8(M5)
Asia	○	-	kPa/MPa	○	○	R1/8(M5)
Europe	-	○	kPa/MPa	○	○	G1/8(M5)
North America	○	○	kPa/MPa	○	○	NPT1/8(M5)

Note 1: Refer to page 24 for the unit seal label to be attached.

<Table 1>

Type	Model no.	Port size	Output type	Remarks
Standard type	PPX-R01N-6M-(J)-KA	M5 female thread +R (PT) 1/8 male thread	NPN transistor and open collector	For Asia
	PPX-R10N-6M-(J)-KA			
High function type	PPX-R01NH-6M-KA			
	PPX-R10NH-6M-KA			
Standard type	PPX-R01P-6G-(J)-KA	M5 female thread +G1/8 male thread	PNP transistor and open collector	For Europe
	PPX-R10P-6G-(J)-KA			
High function type	PPX-R01PH-6G-KA			
	PPX-R10PH-6G-KA			
Standard type	PPX-R01N-6N-(J)-KA	M5 female thread +NPT1/8 male thread	NPN transistor and open collector	For North America
	PPX-R01P-6N-(J)-KA		PNP transistor and open collector	
	PPX-R10N-6N-(J)-KA		NPN transistor and open collector	
	PPX-R10P-6N-(J)-KA		PNP transistor and open collector	
High function type	PPX-R01NH-6N-KA		NPN transistor and open collector	
	PPX-R01PH-6N-KA		PNP transistor and open collector	
	PPX-R10NH-6N-KA		NPN transistor and open collector	
	PPX-R10PH-6N-KA		PNP transistor and open collector	

Analog output voltage - pressure characteristics

● PPX-R01NH
R01PH

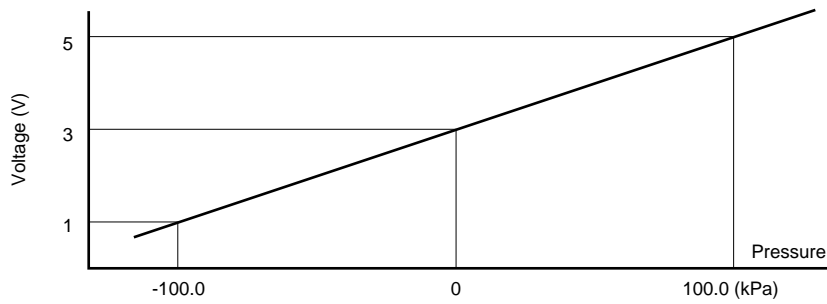

● PPX-R10NH
R10PH

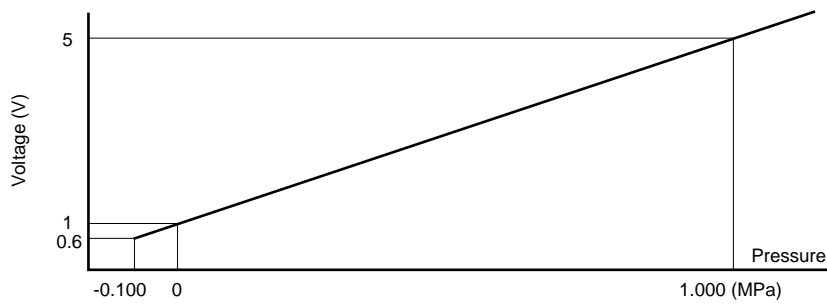

Analog output current - pressure characteristics

● PPX-R01NH
R01PH

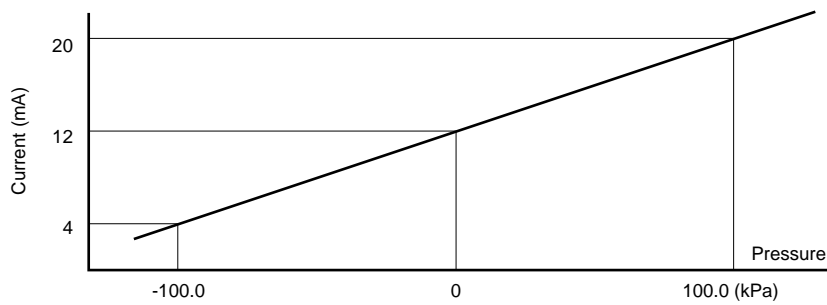

● PPX-R10NH
R10PH

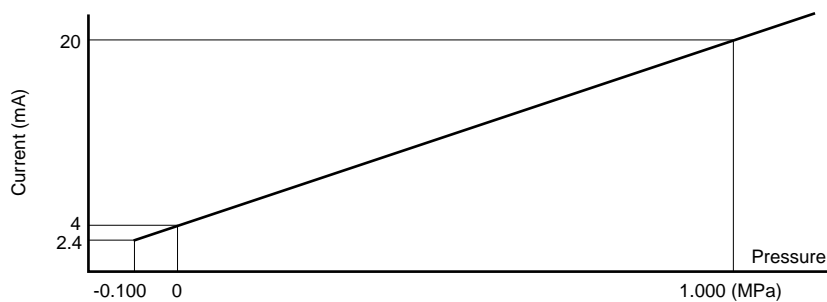

Dimensions 

● PPX-R**-6M/6N (R/NPT thread)

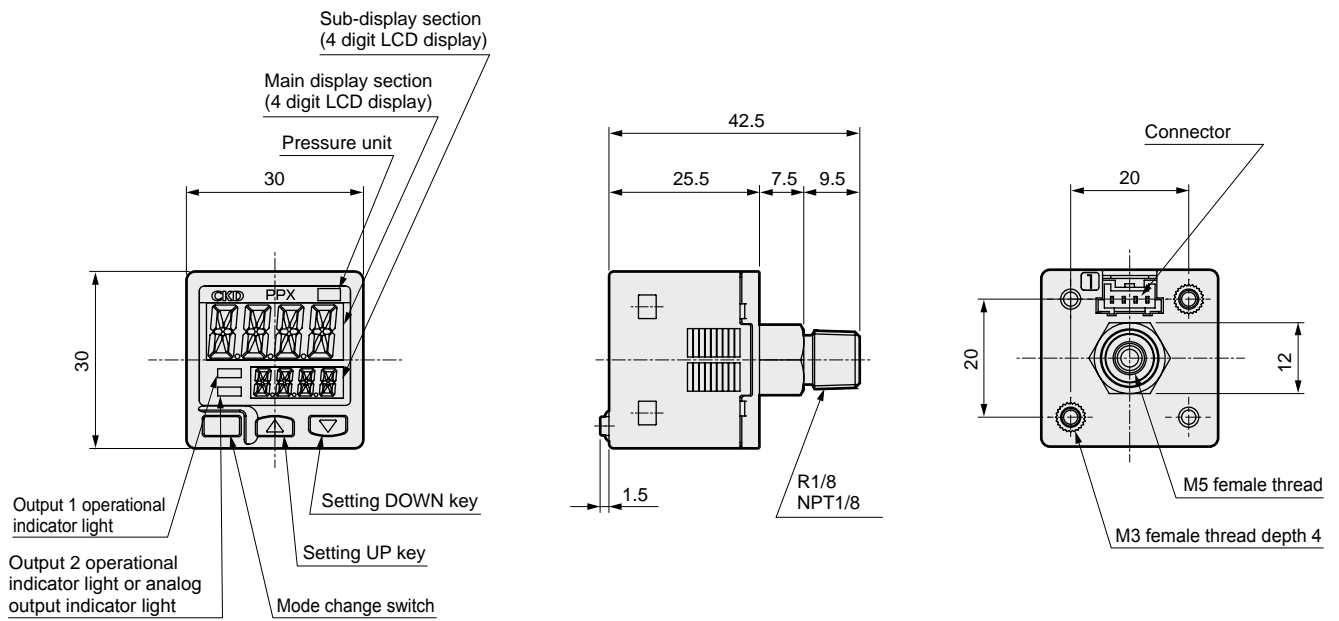

● PPX-R**-6G (G thread)

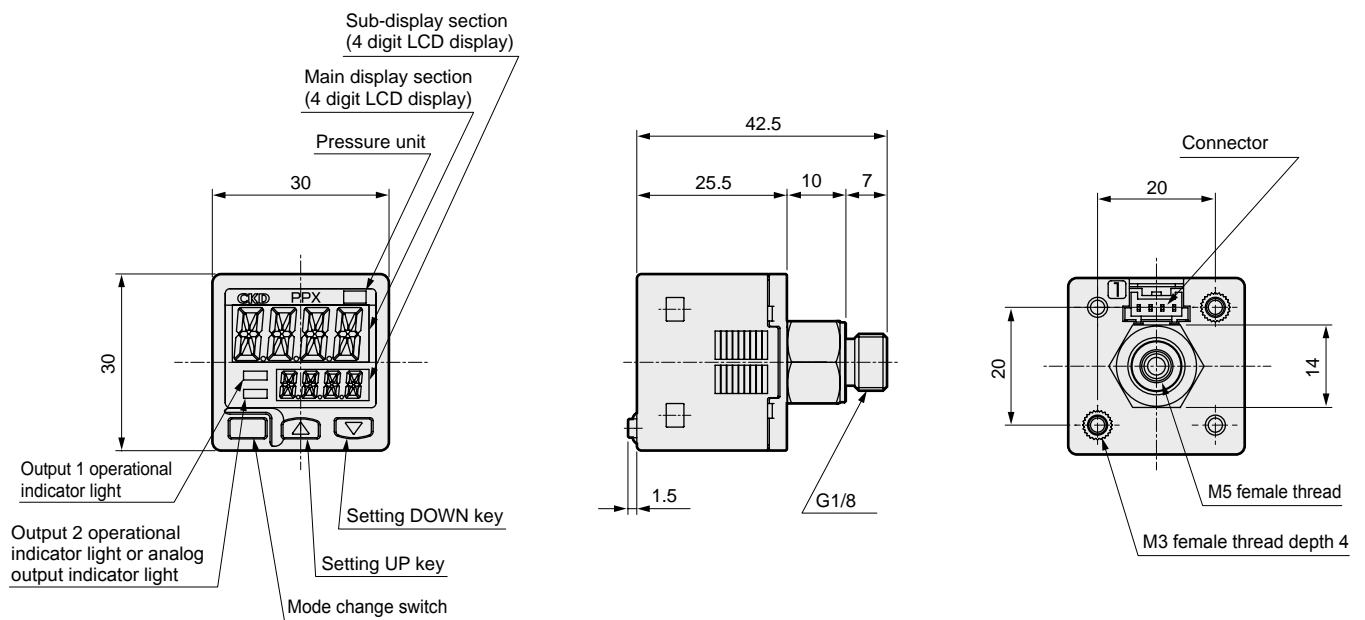

Dimensions with options



● Bracket (PPX-KL)

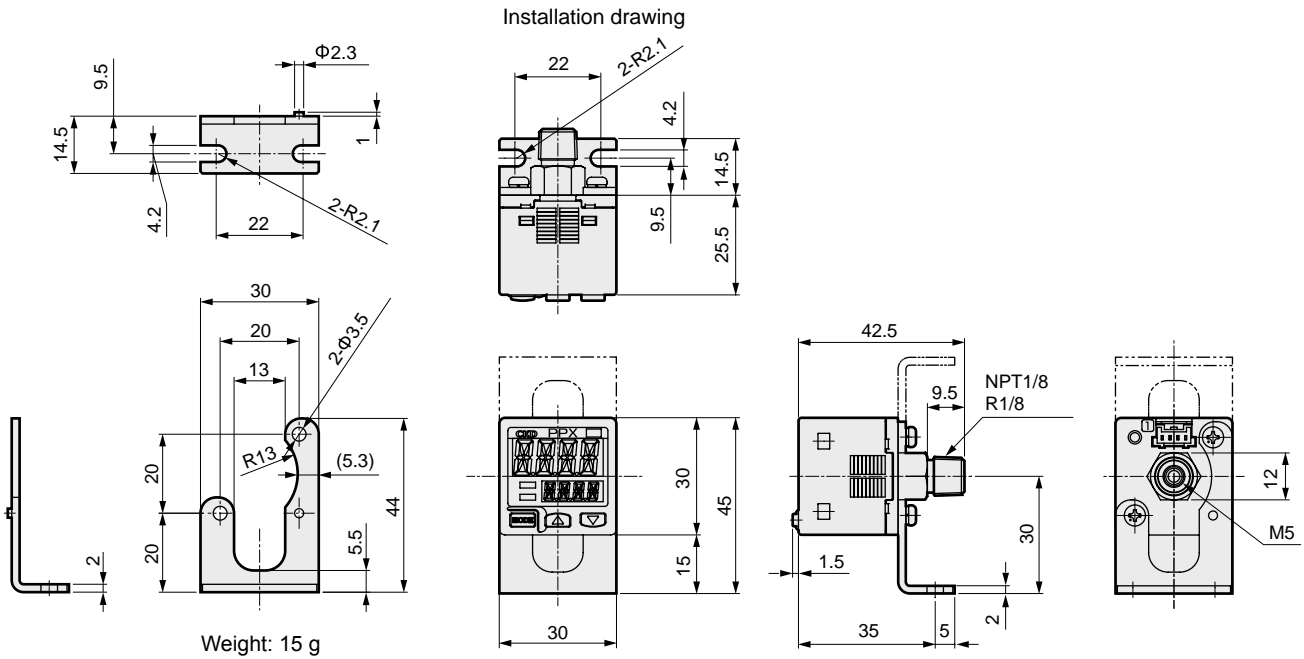

● Panel bracket (PPX-KHS) installation drawing

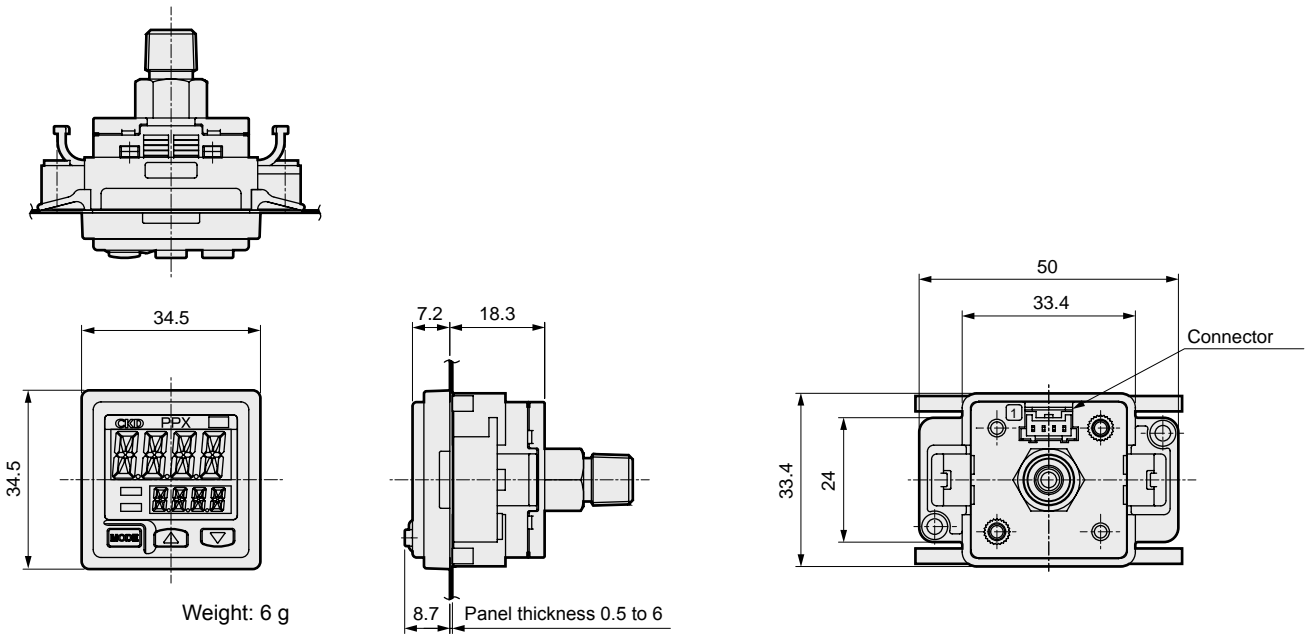

Panel cut dimensions

Installing 1 pc.

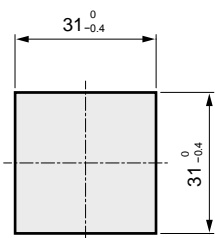

Installing consecutive n pcs. horizontally.

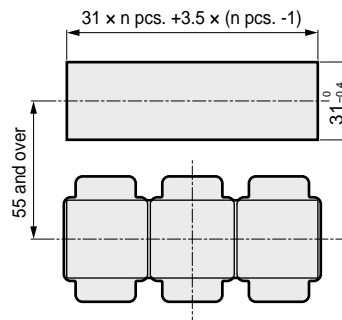

(Note 1): Panel thickness must be 0.5 to 6mm.

Installing consecutive n pcs. vertically.

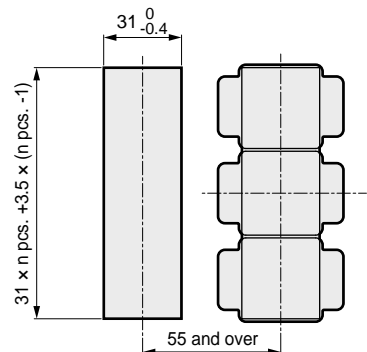

(Note 1): Panel thickness must be 0.5 to 6mm.

Dimensions with options



● Front protective cover (PPX-KCB) installation drawing

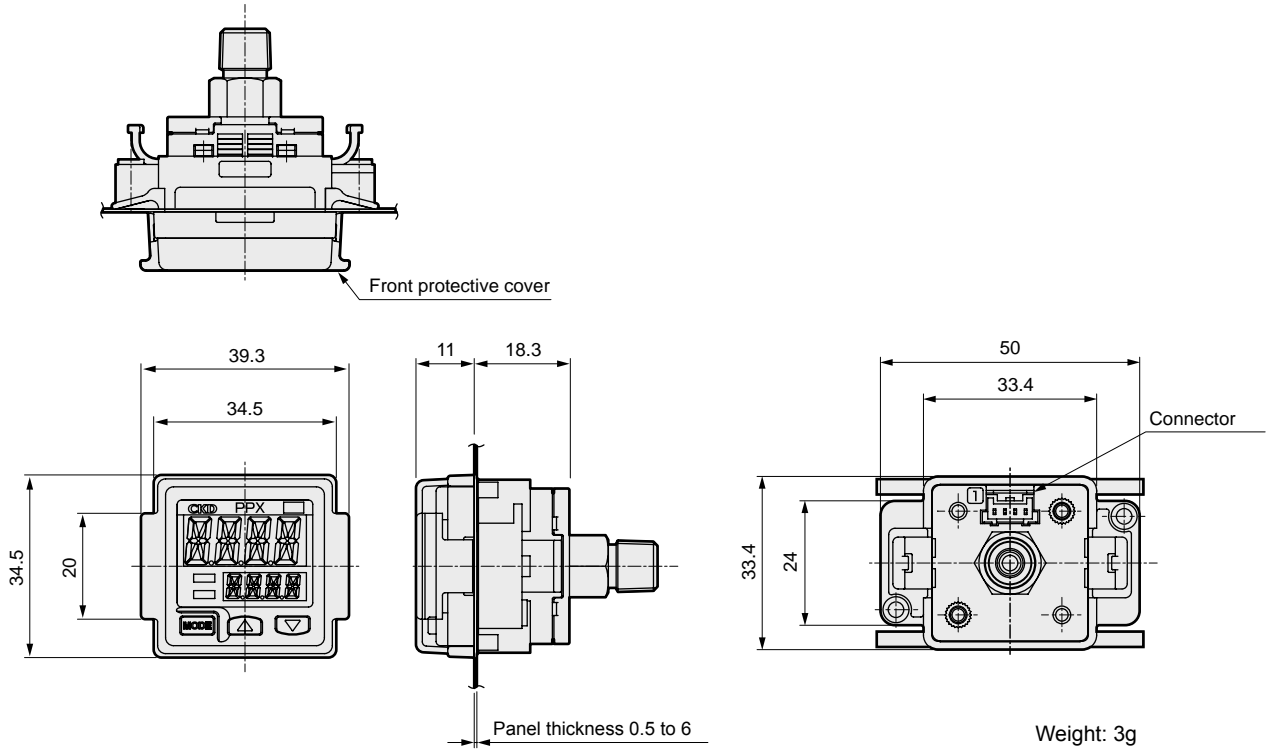

● Cable with connector (PPX-C*)

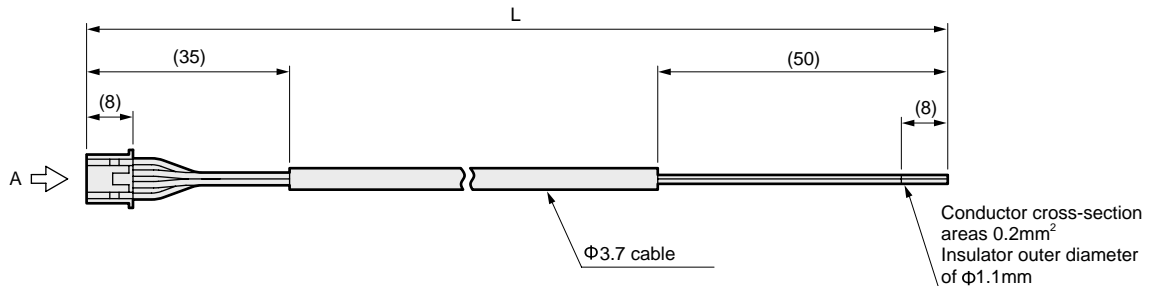

(JST MFG CO. LTD.)

0V	Blue	④
Standard type: comparison output 2 High function type: analog voltage output or external input	White	③
Comparison output 1	Black	②
+V	Brown	①
Terminal name	Insulant color	Terminal number

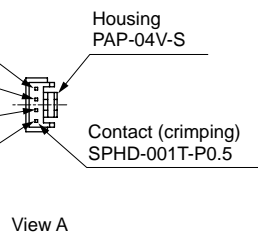

Model no.	Cable length	Weight g
PPX-C1	1m	Approx. 20g
PPX-C2	2m	Approx. 40g
PPX-C3	3m	Approx. 60g
PPX-C5	5m	Approx. 100g

● Connector set (PPX-CN)

- Housing: JST MFG CO. LTD. PAP-04V-S
- Contact: JST MFG CO. LTD. SPHD-001T-P0.5

Circuit and connection

NPN output type

- Standard type

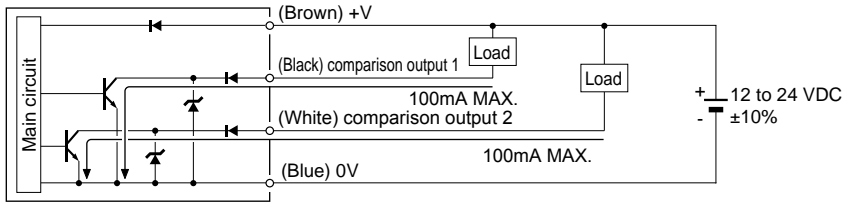

- High function type

<External input connection sample>

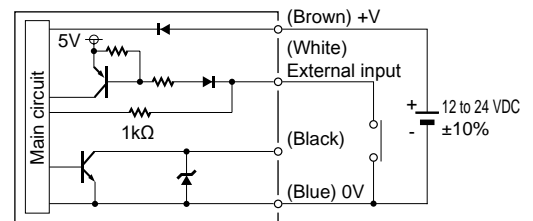
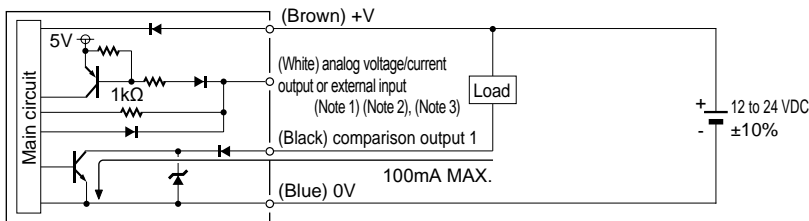

PNP output type

- Standard type

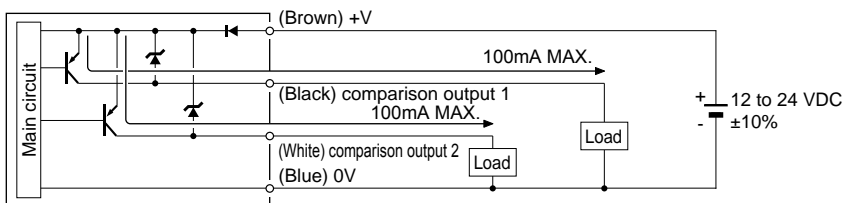

- High function type

<External input connection sample>

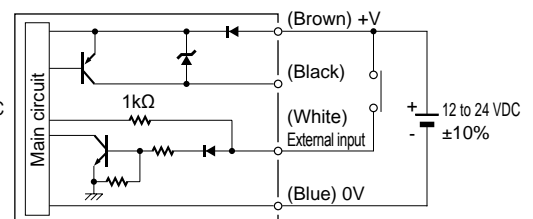
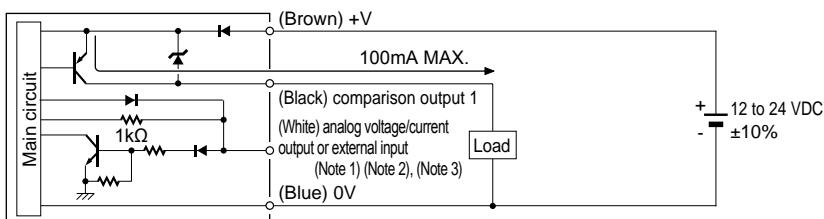

(Note 1): Set output load resistor as 250Ω (MAX.), when analog current output.

(Note 2): Note that more than 5V voltage will be generated, when analog current output.

(Note 3): Be careful with input impedance of connecting device, when you use analog voltage output.

Also, note that voltage will be lower because of cable resistor, when cable is extended.



Digital pressure sensor Oil-prohibited type

PPX-P12 Series

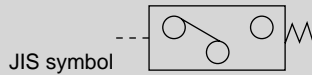

Overview

- Oil-prohibited treatment (degreasing) at gas contact areas (piping ports, etc.)
- Silicone grease-free at gas contact areas (no grease used at gas contact areas)

Features

- Ideal for applications with liquid crystal, semiconductor, food, medical, and electronic component etc., where grease must be avoided.
- Ideal for pressure detection on painting lines because no grease is used.

Specifications

Specifications are the same as standard type. Refer to page 1 for details.

How to order

PPX - **R01** **N** - 6M - P12

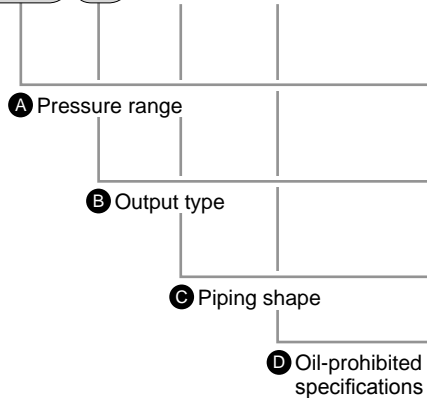

Symbol	Descriptions
A Pressure range	
R01	-100.0 to 100.0kPa
R10	-0.100 to 1.000MPa
B Output type	
N	NPN transistor output 2 point
NH	NPN transistor output 1 point + analog voltage/current output or external input
C Piping shape	
6M	R 1/8, M5 female thread
D Oil-prohibited specifications	
P12	Oil-prohibition type

* 2 m connector cable attached.

Dimensions

Dimensions are the same as standard type. Refer to page 4 for details.

Operation mode and output operation

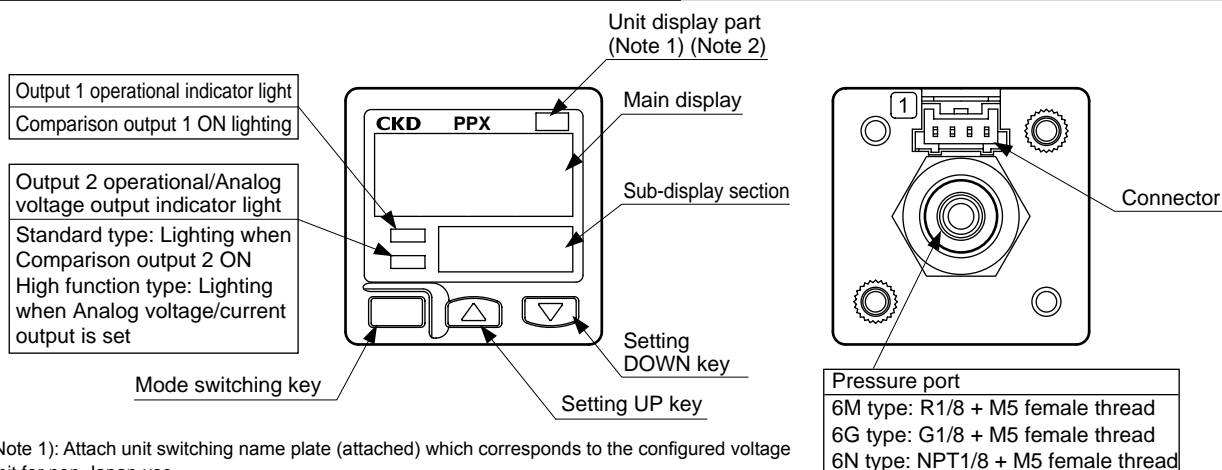

(Note 1): Attach unit switching name plate (attached) which corresponds to the configured voltage unit for non-Japan use.

(Note 2): Only "MPa" and "kPa" are available to set for non-Japan use.

Operation mode and output operation

- The output mode can be selected from EASY MODE, hysteresis mode, or window comparator mode for comparison output 1 and comparison output 2.
See "Menu setting mode" (page 11), Comparison output 1/2 output mode setting, for details.

EASY MODE

- This mode is used to turn comparison output on or off.

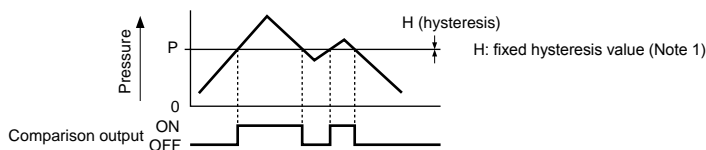

Note 1: Hysteresis can be set to eight stages.

See "PRO mode" (page 13), Changing fixed hysteresis, for details on setting.

Note 2: "P - I" appears on the sub display for comparison output 1, and "P - Z" appears for comparison output 2.

Hysteresis mode

- This mode randomly sets comparison output hysteresis and turns it on or off.

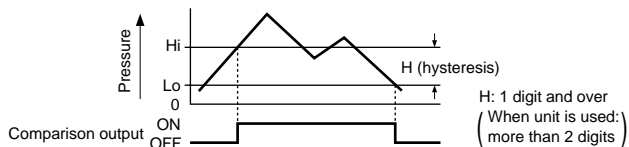

Note 1: "Hi - I" and "Lo - I" appear on the sub display for comparison output 1, and "Hi - Z" and "Lo - Z" for comparison output 2.

Window comparator mode

- This mode is used to turn comparison output on or off within the setting range.

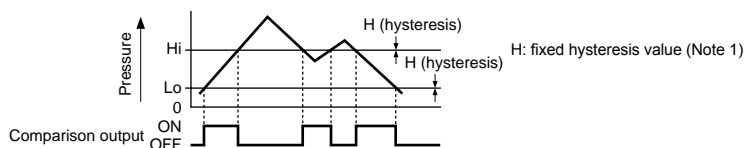

(Note 1): Hysteresis can be set to eight stages.

See "PRO mode" (page 13), Changing fixed hysteresis, for details on setting.

(Note 2): "Hi - I", "Lo - I" appears on the sub display for comparison output 1, and "Hi - Z", "Lo - Z" appears for comparison output 2.

(Note 3): Setting interval between Lo side and Hi side should be greater than hysteresis fixed value.

RUN MODE

Setting threshold

- See "Menu setting mode", Comparison output 1/2 output mode setting, and Analog voltage/current output/external input switching for details on setting.
- Threshold will be set on sub display part. Main display part will not be changed.

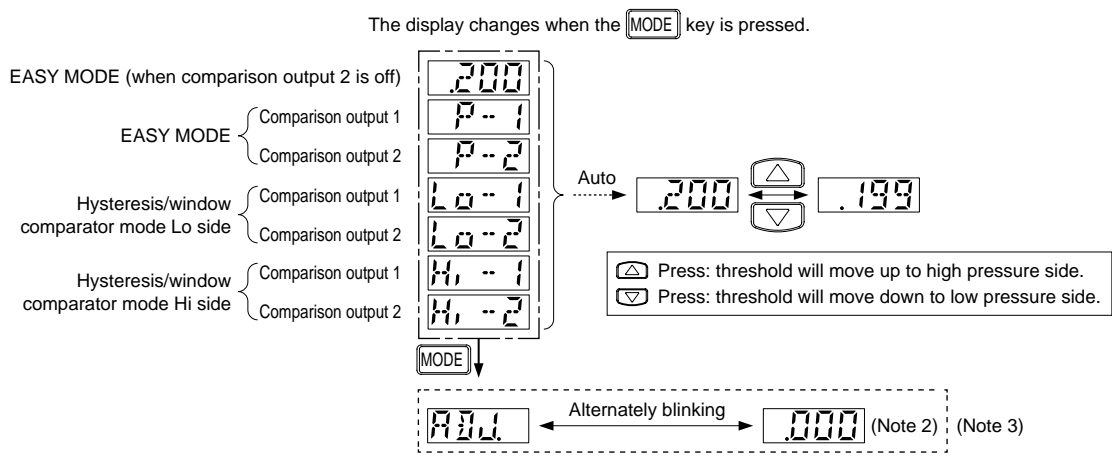

- (Note 1): "UP" (exceeding maximum) or "DOWN" (exceeding minimum) lights on the sub display when exceeding the set pressure range. When the threshold is set for the hysteresis mode/window comparator mode, "DOWN" is displayed if the Hi side threshold is lower than the Lo side threshold.
- (Note 2): It displays auto reference value and remote zero adjusting value. For more details, please refer to "Auto reference function" or "Remote zero adjusting function".
- (Note 3): Part in dash line will be displayed only when it is set either "ZERO" or "AREF". Please refer to <Analog voltage/current output/external input switching> in "Menu setting mode" for how to set.

Zero adjusting

- The zero adjusting function forcibly sets the pressure display to zero when the pressure port is released to atmospheric pressure.

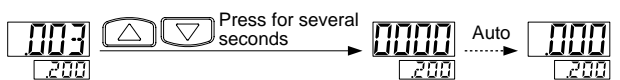

Key lock

- The key lock function disables key operations so that conditions set for setting modes cannot be mistakenly changed.

(Setting key lock)

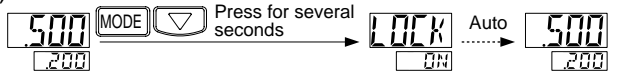

(Releasing key lock)

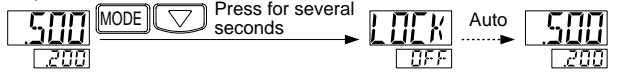

Peak/bottom hold

- The peak and bottom hold function displays peak and bottom varying pressure.
- The peak value is displayed on the main display, and the bottom value is displayed on the sub display.
- High pressure side is peak value, low pressure side is bottom value.

(Setting peak/bottom hold)

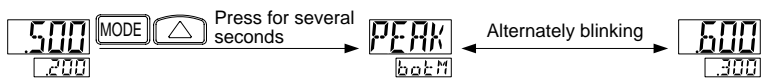

(Releasing peak/bottom hold)

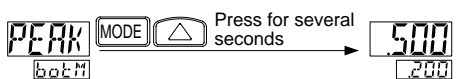

Menu setting mode

● If the mode switching key is held down long while a setting is made, the RUN mode opens and changed items are set.

RUN MODE

↓ [MODE] Hold down for 2 secs.

<Setting comparison output 1 output mode>

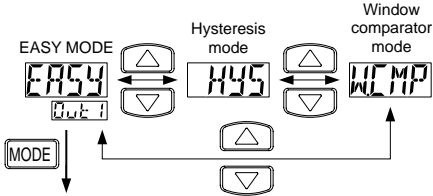

● Standard type

<Setting comparison output 2 output mode> (Note 1)

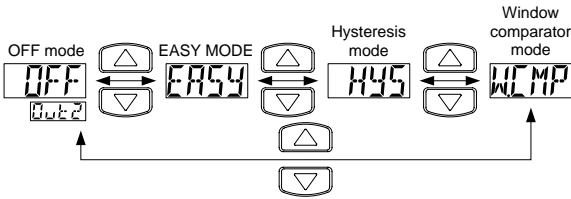

● High function type

<Analog voltage/current output/external input switching>

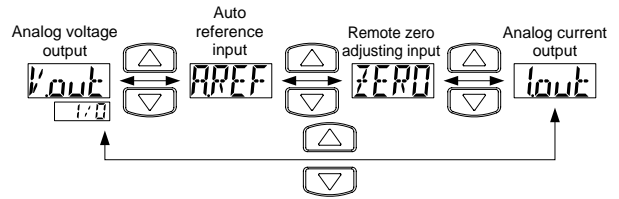

[MODE] ↓

● Standard type

<Switching N.O./N.C> (Note 1)

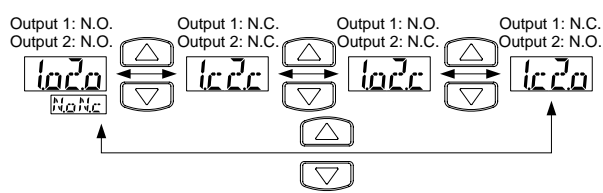

● High function type

<Switching N.O./N.C>

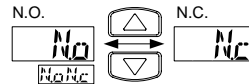

[MODE] ↓

<Setting response time>

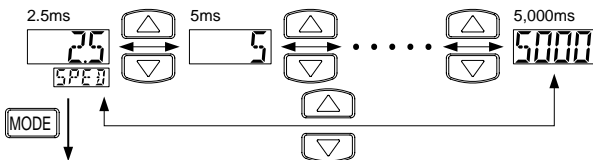

<Switching main display section display color>

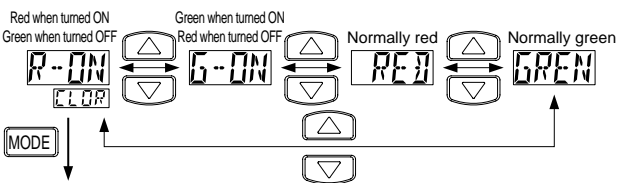

<Switching unit> (note 2)

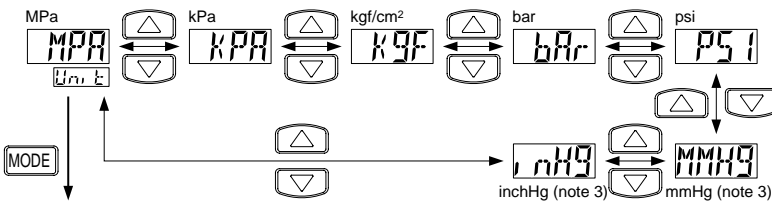









RUN MODE

(Note 1): If the comparison output 2 output mode setting is set to "OFF", the display at N.O./N.C. changeover is the same as the high function type.

(Note 2): Only "MPa" or "kPa" is available to set for Japan use. Also, setting items for unit switching will not be displayed for low pressure types.

(Note 3): The high pressure type is not displayed.

Setting descriptions	Initial status	Descriptions
Setting comparison output 1 output mode		Set comparison output 1 output mode.
Setting comparison output 2 output mode (Only standard type)		Set comparison output 2 output mode.
Analog voltage/current output/ external input switching (Only high function type)		Analog voltage, current output, auto reference input, or remote zero adjusting input can be switched.
Switching N.O./N.C	Low pressure type  High pressure type 	Set normal open (N.O.) or normal close (N.C.).
Setting response time		Set the response time. Response time can be selected from 2.5ms, 5ms, 10ms, 25ms, 50ms, 100ms, 250ms, 500ms, 1,000ms, or 5,000ms.
Switching main display section display color		Display color of display part can be switched.
Switching unit	Low pressure type  High pressure type 	The pressure unit can be changed.

PRO MODE

- The mode will be switched to PRO MODE if the mode switchover key is held down for 4 seconds during RUN MODE.
- Hold down the mode switchover key for several seconds to switch to RUN MODE during the setting. In that case, the changed descriptions are set.
- The left end display section is in the initial state.

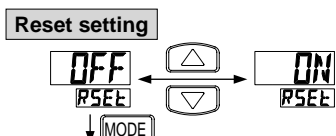
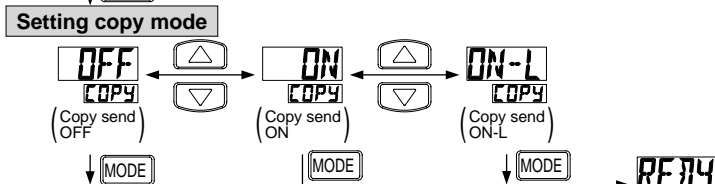
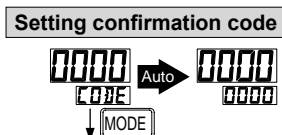
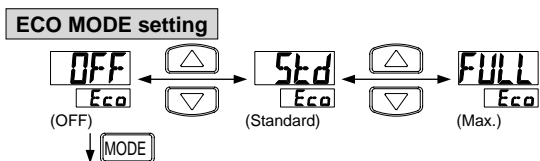
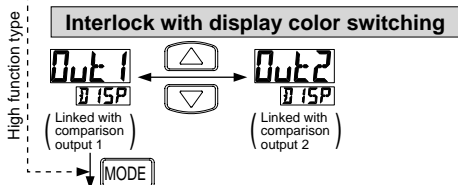
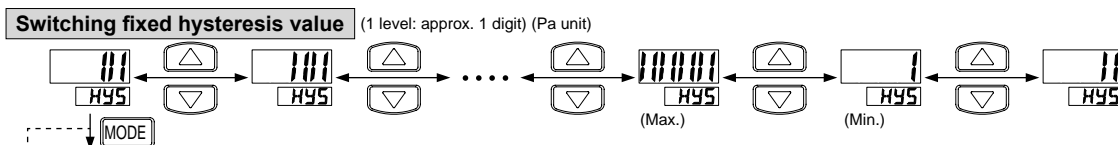
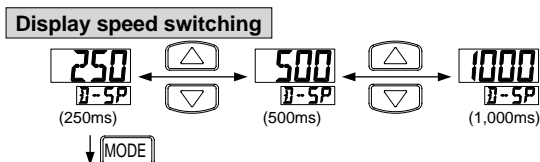
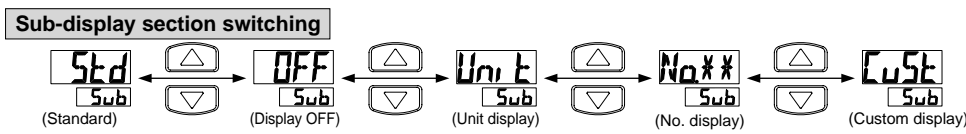
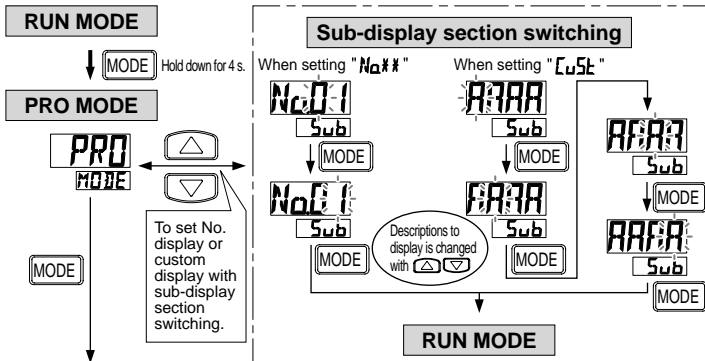

RUN MODE

Setting descriptions	Initial status	Descriptions
Sub-display section switching	Std	Sub-display section display during RUN MODE can be switched. "OFF": Nothing is displayed. "Unit": The current pressure unit is displayed. "No**": Specified number is displayed. "LcSL": Specified number, character (some characters cannot be displayed) or symbol is displayed.
Display speed switching	250	Display speed of pressure displayed in the main display section can be switched.
Fixed hysteresis value switching	01	Hysteresis of EASY MODE and WINDOW COMPARATOR MODE can be set. (8 steps)
Switching display color (Only standard type)	00L1	Comparison with the setting details with display colors switched at the main display part of menu setting mode. Interlock with either output 1 or comparison output 2 can be switched.
ECO MODE setting	OFF	Power consumption can be reduced. "OFF": Normally (ECO MODE OFF) "Std": Display section gets dark if the key operation is not done for 5 seconds in RUN MODE. "FULL": Display section is turned OFF if the key operation is not done for 5 seconds in RUN MODE. Hold down any key to display normal state temporarily.
Setting confirmation code	0000	The current setting details can be checked. Refer to the code list for codes.
Setting copy mode	OFF	A copy of master side sensor setting details can be made to a slave side sensor. Refer to "Setting copy function" on page 15 for the details. "ON": A copy of setting details is sent. "ON-L": A copy of setting details is sent, then key lock applies to the slave side sensor.
Reset setting	OFF	Reset to the initial state. If you press mode switchover key while "ON", initial status (factory settings) will be retrieved.

Code list

Code	1st digit		2nd digit			3rd digit	4th digit	
			Standard type		High function type		Display color of main display section	Only standard type
	Comparison output 1 output mode	N.O./N.C. switching	Comparison output 2 output mode	N.O./N.C. switching	Analog voltage output/external input	Threshold value display		Display color interlock
0	EASY	N.O.	OFF	OFF	Analog voltage output	P-1, Lo-1	Red when turned ON	Comparison output 1
1		N.C.	EASY	N.O.	Auto reference	Hi-1		Comparison output 2
2	Hysteresis	N.O.	Hysteresis	N.C.	Remote zero adjusting	P-2, Lo-2	Green when turned ON	Comparison output 1
3		N.C.		N.O.	Analog voltage output	Hi-2		Comparison output 2
4	Window comparator	N.O.	Window comparator	N.C.	-	ADJ.	Normally red	Comparison output 1
5		N.C.		N.O.	-	-		Comparison output 2
6	-	-	-	N.C.	-	-	Normally green	Comparison output 1
7	-	-	-	-	-	-		Comparison output 2

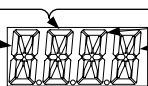

Code	5th digit	6th digit	7th digit	8th digit
	Response time	Unit switching	Display speed	ECO MODE
0	2.5ms	MPa	250ms	OFF
1	5ms	kPa	500ms	Std
2	10ms	kgf/cm ²	1,000ms	Full
3	25ms	bar	-	-
4	50ms	psi	-	-
5	100ms	mmHg	-	-
6	250ms	inchHg	-	-
7	500ms	-	-	-
8	1,000ms	-	-	-
9	5,000ms	-	-	-

Only for foreign markets (with unit change)

Setting copy function

- This makes a copy of setting details to the slave side sensor from the master side sensor.

- A copy between different models cannot be made.
- The setting copy function applies to one slave side sensor per master side sensor.

<Installation procedure>

- ① Set setting copy mode of the master sensor as "sending ON" or "ON-L", then press the mode switchover key to set ready state. Refer to "Setting copy mode" in the PRO MODE section on page 13 for details.
- ② Turn off the power of master side sensor.
- ③ Wire between master and slave sides as the following diagram.

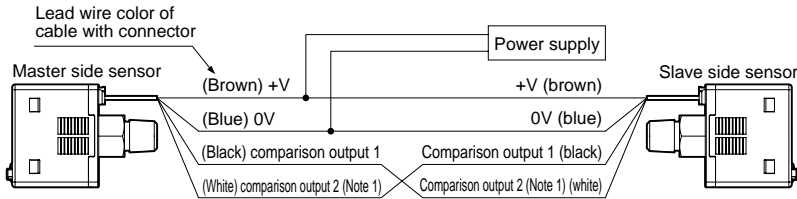

(Note 1): Analog voltage output/external input applies for high function type.

- ④ Turn the power of the master and slave side sensors ON at the same time. (Note 2) (Note 3)
 - ⑤ Setting details are 16-bit encoded, and displayed with orange in the main display section of the master side sensor, then a copy starts.
 - ⑥ The same codes as the procedures ⑤ are displayed with green in the main display section of the slave side sensor, and "⏏" is displayed in the sub-display section. (A copy is completed).
 - ⑦ Turn off the power of the master and slave side sensors, then remove wiring.
- * If a copy of setting details is repeatedly made to another sensor, follow procedures ③ to ⑥.

(Note 2): A copy of setting details could not be made if power is not turned on at the same time.

(Note 3): Pulse output is outputted from the comparison output 1 output, if power is turned on.

<To reset the master side sensor setting copy mode.>

- ① Turn on power of a master side sensor (with wiring of slave side sensor removed).
- ② Hold down the mode switchover key for 2 seconds.

Auto reference (only high function type)

- Auto reference is the function that corrects the setting of detection pressure as the reference pressure when auto reference input.
- Based on detection pressure P(a) when auto reference input, the setting (1)' is automatically corrected to "setting (1)+P(a)".

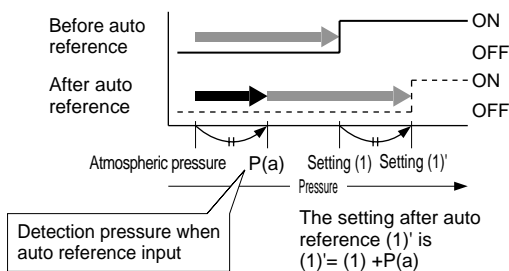

Setting available range and set pressure range after correcting

- The set pressure range is wider than the rated pressure range in accordance with auto reference.

If the corrected settings exceed set pressure range when auto reference input, the setting is automatically corrected to set pressure range. Do not exceed set pressure range.

Operation chart

<Normal (N.O. setting for each comparison output)>

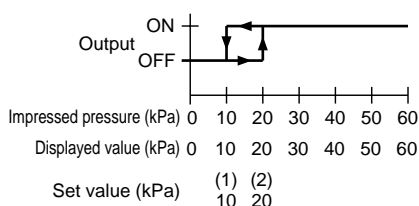

<<Auto reference input (N.O. setting for each comparison output)>>

- Detection pressure when auto reference input: 10kPa
- Output mode: Hysteresis mode

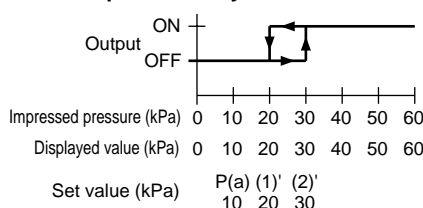

(Note 1): With EASY MODE and WINDOW COMPARATOR MODE, the setting is shifted in the same manner.

- Detection pressure is set to "zero", if the analog voltage output/external input switching setting is changed, or if power is turned ON again when auto reference input.
- The auto reference input can be checked when setting the threshold value in the RUN MODE. Refer to the threshold value setting on Page 10; RUN MODE for the details.

Remote zero adjusting (only high function type)

- Remote zero adjusting is the function that forcibly set the pressure at that time to "zero" with an external input signal.

The setting cannot be corrected when remote zero adjusting input. Do not exceed set pressure range for the pressure and the setting during remote zero adjusting.

Operation chart

<Normal (N.O. setting for each comparison output)>

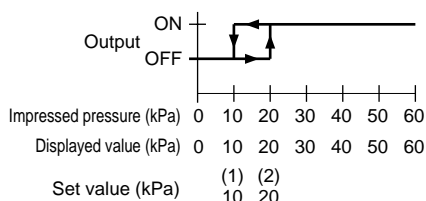

<<Remote zero adjusting input (N.O. setting for each comparison output)>>

- Pressure for remote zero adjusting input: 10kPa
- Output mode: Hysteresis mode

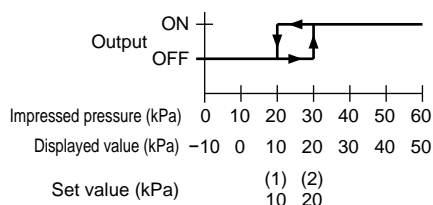

(Note 1): With EASY MODE and WINDOW COMPARATOR MODE, the setting is shifted in the same manner.

- If analog voltage output/external input setting is changed, or if the power is turned ON again, the remote zero adjusting value is cleared, and remote zero adjusting function goes back to the normal operation with atmospheric pressure standard. Remote zero adjusting value can be checked when setting the threshold value in RUN MODE. Refer to the threshold value setting in "RUN MODE" section on Page 10 for the details.

Error display

Error display	Descriptions	Measures
E-1	The load is short-circuited, and overcurrent flows.	Check a load after the power turned OFF.
E-3	Pressure is applied during zero point adjustment.	Apply atmospheric pressure to the pressure port, then perform zero adjustment again.
E-4	External input overflows the rated pressure range.	Reset applied pressure to the rated pressure range.
E-5	Communication error (disconnection or incorrect connection, etc.)	Check wiring before using the copy function.
E-6	Communication error (A different model is used.)	Check the configuration used with same models before using the copy function.
10 10	Applied pressure reaches the upper limit of display pressure range.	Set applied pressure within rated pressure range.
10 10	Applied pressure reaches the lower limit (back pressure) of display pressure range.	

Example of setting operation per application EASY MODE

(Note 1): This is the example of setting from default setting (default).

(Note 2): If the setting conditions are unknown, operate <reset setting> in PRO MODE, and reset to default before using.

● Suction confirmation

To EASY MODE

R01 type (-100.0 to 100.0kPa)

- Start from the mode when power turned ON (RUN MODE).
- If RUN MODE is not selected, hold down the "MODE" key for several seconds to display the RUN MODE state.

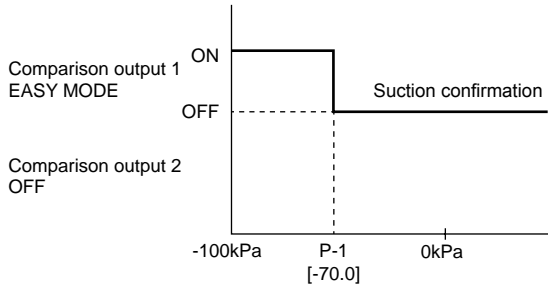

RUN MODE screen

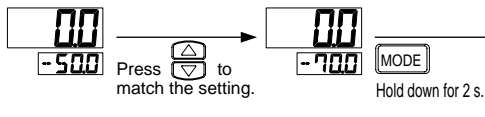

Menu setting mode screen

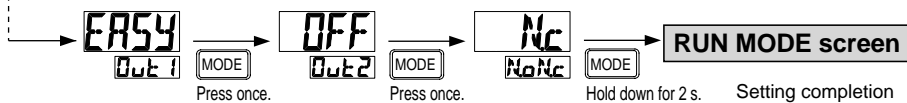

● Suction + vacuum break confirmation

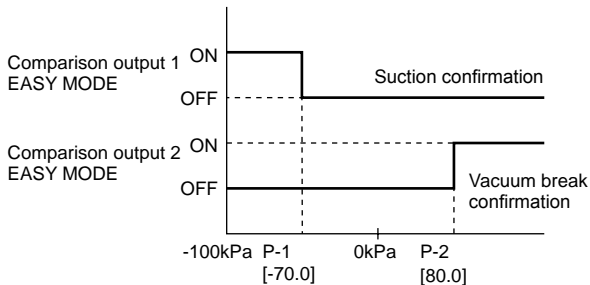

RUN MODE screen

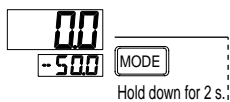

Menu setting mode screen

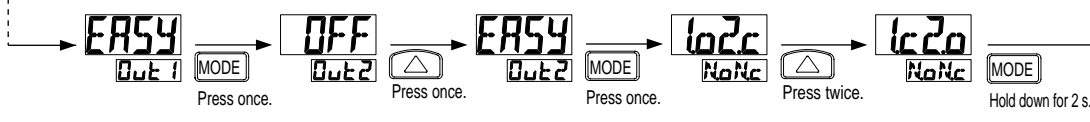

RUN MODE screen

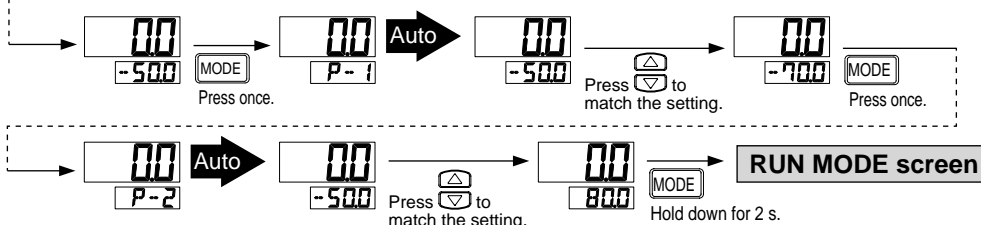

Example of setting operation per application HYS MODE (hysteresis mode)

(Note 1): This is an example of setting from default setting.

(Note 2): If the setting conditions are unknown, operate <reset setting> in PRO MODE, and reset to default before using.

● Suction confirmation

To HYS MODE (hysteresis mode)
R01 type (-100.0 to 100.0kPa)

- Start from the mode when power turned ON (RUN MODE).
- If RUN MODE is not selected, hold down the "MODE" key for several seconds to display the RUN MODE state.

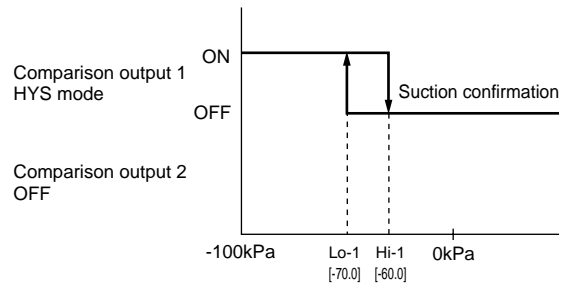

RUN MODE screen

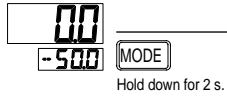

Menu setting mode screen

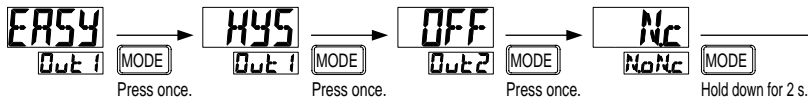

RUN MODE screen

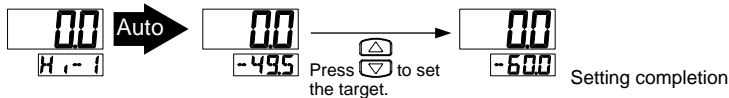
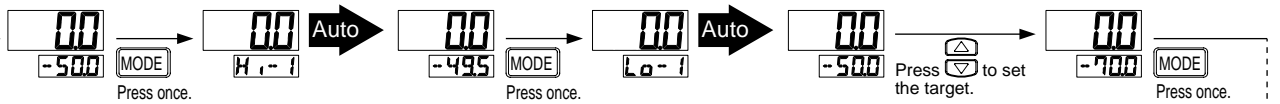

● Suction + vacuum break confirmation

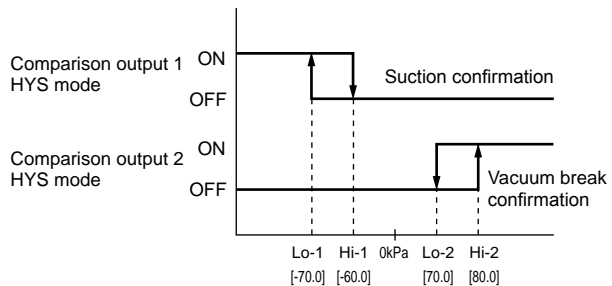

RUN MODE screen

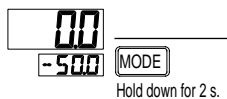

Menu setting mode screen

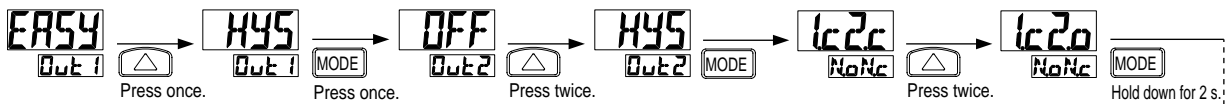

RUN MODE screen

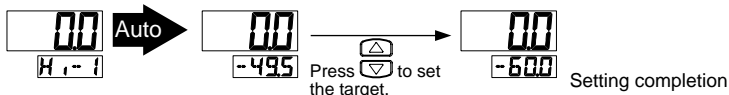
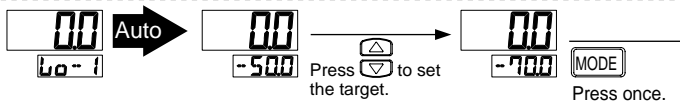
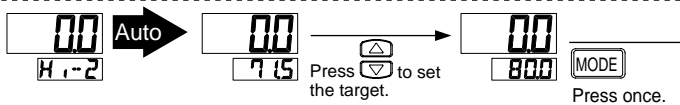
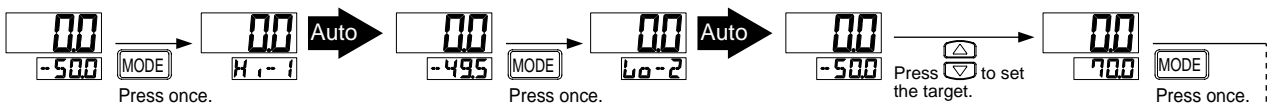

Example of setting operation per application

WCMP MODE (window comparator mode)

(Note 1): This is an example of setting from default setting.

(Note 2): If the setting conditions are unknown, operate <reset setting> in PRO MODE, and reset to default before using.

● Source pressure confirmation

To WCMP MODE (window comparator mode)

R10 type (-0.100 to 1.000MPa)

- Start from the mode (RUN MODE) when power turned ON.
- If RUN MODE is not selected, hold down the "MODE" key for a while to enter RUN MODE.

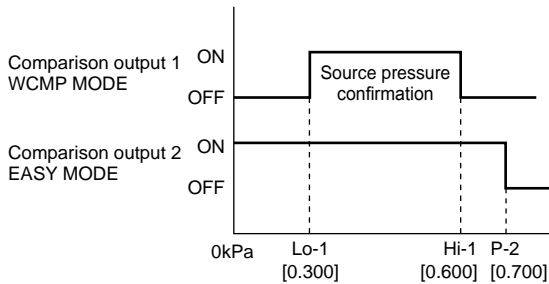

RUN MODE screen

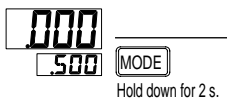

Menu setting mode screen

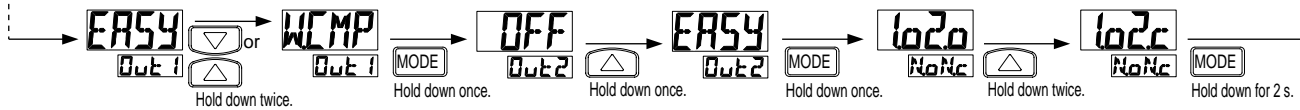

RUN MODE screen

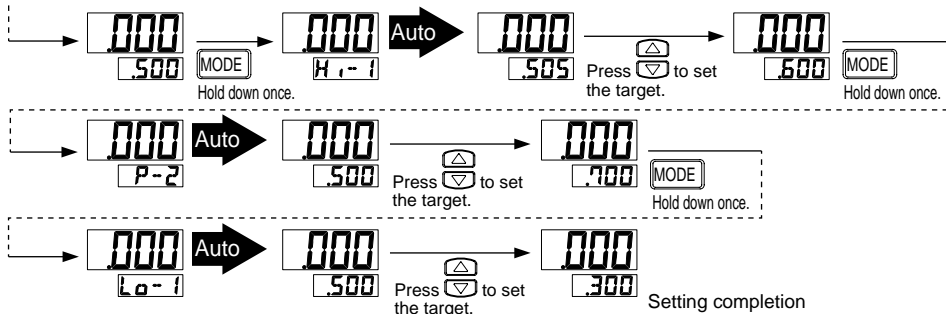



Safety precautions

Always read this section before starting use.

When designing and manufacturing a device using CKD products, the manufacturer is obligated to check that device safety mechanical mechanism, pneumatic control circuit, or water control circuit and the system operated by electrical control that controls the devices is secured.

It is important to select, use, handle, and maintain the product appropriately to ensure that the CKD product is used safely.

Observe warnings and precautions to ensure device safety.

Check that device safety is ensured, and manufacture a safe device.

WARNING

- 1 This product is designed and manufactured as a general industrial machine part. It must be handled by an operator having sufficient knowledge and experience in handling.**
 - 2 Use this product in accordance with specifications.**

Contact CKD when using the product outside the unique specifications range, when using it outdoors, and when using it under the conditions and environment below. Do not attempt to modify or additionally machine the product.

 - ① Use for special applications requiring safety including nuclear energy, railroad, aviation, ship, vehicle, medical equipment, equipment, or applications coming into contact with beverage or food, amusement equipment, emergency shutoff circuits, press machine, brake circuits, or for safeguard.
 - ② Use for applications where life or assets could be adversely affected, and special safety measures are required.
 - 3 Observe corporate standards and regulations, etc., related to the safety of device design and control, etc.**

ISO4414, JIS B 8370 (pneumatic system rules)
JFPS2008 (principles for pneumatic cylinder use and selections)
Such as High Pressure Gas Maintenance Law and Occupational Safety and Sanitation Laws, other safety rule and corporate standards and regulations
 - 4 Do not handle, pipe, or remove devices before confirming safety.**
 - ① Inspect and service the machine and devices after confirming safety of the entire system related to this product.
 - ② Note that there may be hot or charged sections even after operation is stopped.
 - ③ When inspecting or servicing the device, turn off the energy source (air supply or water supply), and turn off power to the facility. Discharge any compressed air from the system, and pay enough attention to possible water leakage and leakage of electricity.
 - ④ When starting or restarting a machine or device that incorporates pneumatic components, make sure that the system safety, such as pop-out prevention measures, is secured.
 - 5 Observe warnings and cautions on the pages below to prevent accidents.**
- The safety cautions are ranked as "DANGER", "WARNING" and "CAUTION" in this section.

 **DANGER:** When a dangerous situation may occur if handling is mistaken leading to fatal or serious injuries, or when there is a high degree of emergency to a warning.

 **WARNING:** When a dangerous situation may occur if handling is mistaken leading to fatal or serious injuries.

 **CAUTION:** When a dangerous situation may occur if handling is mistaken leading to minor injuries or physical damage.

Note that some items described as "CAUTION" may lead to serious results depending on the situation. In any case, important information that must be observed is explained.

Disclaimer

- 1 Warranty period**

"Warranty Period" is one (1) year from the first delivery to the customer.
- 2 Scope of warranty**

In case any defect attributable to CKD is found during the term of warranty, CKD shall, at its own discretion repair the defect or replace the relevant product in whole or in part, according to its judgement.

Note that the following faults are excluded from the warranty term:

 - (1) Product abuse/misuse contrary to conditions/environment recommended in its catalogs/specifications
 - (2) Failure caused by other than the delivered product
 - (3) Use other than original design purposes
 - (4) Third-party repair/modification
 - (5) Faults caused by reason that is unforeseeable with technology put into practical use at the time of delivery
 - (6) Failure attributable to force majeure

The warranty mentioned here covers the discrete delivered product. Only the scope of warranty shall not cover losses induced by the failure of the delivered product.
- 3 Compatibility confirmation**

In no event shall CKD be liable for merchantability or fitness for a particular purpose, notwithstanding any disclosure to CKD of the use to which the product is to be put.



Pneumatic components (electronic pressure switch and sensors)

Safety precautions

Always read this section before starting use.

Refer to "Pneumatic, vacuum and auxiliary components CB-024SA".

Design & Selection

WARNING

- Use this product in accordance with specifications.
 - Applications, load current, voltage, temperature, shock and working environment, etc. exceeding the specifications range could lead to destruction and malfunction of peripheral equipment.
- Do not use oxygen, corrosive or combustible gas, or toxic fluid for this product.
- Do not use this product in flammable atmosphere
 - The pressure switch is not explosion proof. Do not use this product in flammable atmosphere, or explosions could occur.
- Do not install the product in completely sealed enclosure.
 - The internal pressure in the closed chamber could change if the fluid leaks in an accident. Use this product in the control box with safety device to control internal pressure, or indoors with no pressure differential from the outside.
- Power supply voltage
Use the product within the specified power supply voltage range. If voltage exceeding specified range is applied, or current power (100 V AC) is applied, circuit damage could occur.
- Load short circuit
Do not short-circuit the load, or circuit damage could occur.
- Incorrect wiring
Avoid incorrect wiring such as connecting to the wrong electrode of the power source, etc., or the circuit damage could occur.

CAUTION

- Applicable fluid
When using applicable fluid other than air; nitrogen gas, etc., oxygen deficiency could be caused. Observe the following instructions.
 - Use this product in well ventilated location.
 - Ventilate the work area when nitrogen gas is being used.
 - Inspect piping regularly, so nitrogen gas does not leak.
 - Non-corrosive gas is materials in the air (nitrogen, carbon dioxide) and inactive gas (argon, neon).
 - To use for pressed air including water and oil, use PPD(3)-S type (stainless diaphragm sensor specifications), which has higher corrosion resistance.
- If this product is used for vacuum suction confirmation, care must be taken for following matters.
 - The pressure exceeding withstanding pressure in the specifications must not be applied to the product if positive pressure of vacuum break is applied.
- Working environment
 - Avoid use in the place that vibration or shock not less than 100m/s² is applied.

- Care must be taken in not exceeding ambient temperature range including piping area.
- Do not use the product in locations that water or oil may contact the products.

- Considering errors, etc. caused by precision/temperature characteristics, decide the setting.
- Care must be taken when this product is used in an interlock circuit.
 - When a pressure switch is used for interlock signals requiring high reliability, provide mechanical guards for a failure, or provide dual interlock as a switch (sensor) other than pressure switch. Conduct inspection regularly to check that the normal operation is done.
- Responsiveness is adversely affected depending on working pressure and capacity of loads. Install a regulator before the sensor if stable reproducibility is required.
- Use conditions to comply with CE marking
 - PPX Series is CE marked products complied with EMC directive. EN61000-6-2 regulation matched to immunity applies to this product. Conditions below are necessary to comply with these standards.
Conditions
 - Length of power line connected to the sensor must be less than 10m.
- Take the following countermeasures to prevent malfunction caused by noise.
 - Provide a line filter in AC power line.
 - Do not share power with an inverter or components causing motor noise, etc.
 - Remove noise from inductive load (such as solenoid valve and relay) with a surge suppressor such as CR or diode in the source side.
 - When using components (such as switching regulator and inverter motor) causing noise around the sensor installation section, ground a frame ground (F.G.) terminal of components.
 - Keep distance between a line connected to sensors and strong magnetic field.
 - Connect to sensors with shield wire.
 - Connect shield wire to the ground of power side.
- When the secondary side control pressure is released to atmosphere as air blow, pressure may fluctuate depending on piping and blow conditions. Execute a test under actual working conditions or contact to CKD.
- Select the product whose flow is not less than the total of that used for sensors when selecting a dryer, an air filter, an oil mist filter and a regulator.

Installation & Adjustment

⚠ WARNING

- Avoid incorrect connection.
 - An incorrect connection may cause a fatal error not only to this product but also peripheral devices.
- DC power not insulated from AC primary side may damage the product and power, so an electric shock could occur.
Do not use the product in this case.
- If a commercially available switching regulator is used for power, ground a frame ground (F.G.) terminal of power.

⚠ CAUTION

- Do not use the product where the product is exposed to direct-sunlight, or may come in contact with water or oil.
- Avoid use in high steam and dirt environments.
- Care must be taken to avoid product contact with organic solvents such as thinner, water, oil and fat.
- Do not put wire, etc. into the pressure port, or diaphragm may be damaged preventing a normal operation.
- Performance could not be guaranteed in strong electromagnetic field.
- Flash air pipe connected to sensors before connecting. Prevent pipe from catching tips of sealing tape when piping.
- Apply adequate torque when connecting pipes.
 - To prevent air leakage and screw damage.
 - Tighten by hand at first, then use a tool to prevent screw thread damage.

Set screw	Tightening torque N·m
M3	0.3 to 0.6
M5	1 to 1.5
Rc1/8	3 to 5



Piping

- Apply a 12mm spanner (14mm for PPX-6G type) on the pressure port hexagon head section to fix, then apply tightening torque 9.8N·m or less if a commercially available joint is connected to the pressure port. A joint or the pressure port section could be broken if too much torque is applied.
Use seal tape to connect joints and prevent air leak.

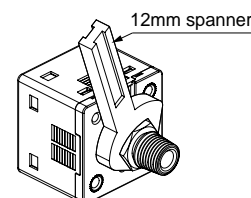

- Please be careful when unpacking, as piping port is degreased and cleaned. (PPX-P12)

Installation

⚠ WARNING

- Sensor bracket PPX-KL is available.
If a sensor is installed with a bracket, etc., tightening torque must be 0.5N·m or less.

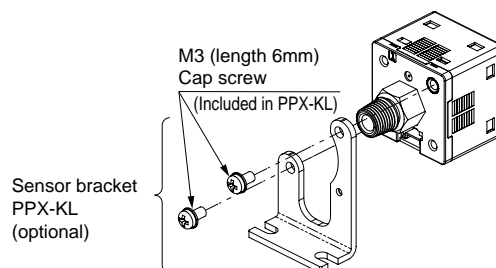

- Panel bracket PPX-KHS (optional) and front cover PPX-KCB (optional) are available.

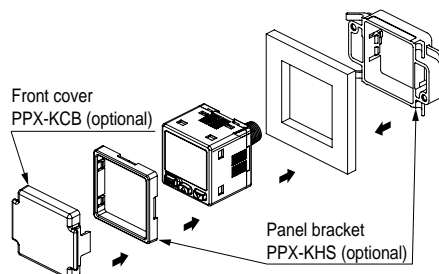

Installation & Adjustment

CAUTION

■ Care must be taken for protection of body and lead wire.

- Do not apply stress to cable leading or connector section directly.

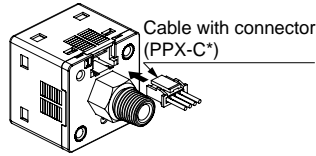

- Do not dent or drop the body. Do not apply excessively repeated bending force and tension to lead wire, or could result in disconnection.
- Connect an elastic material as a cable bearer to the movable part.

■ Connector wiring

- Insert cable with connector PPX-C* into the connector section of this product as right when connection.
- Pull out the connector while pressing the jaw of cable with connector when disconnecting.
- If the cable section is pulled out without pressing the jaw when disconnecting, the cable or connector could be broken.

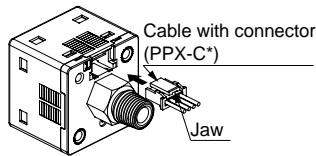

<Connector>
 Contact: SPHD-001T-P0.5
 Housing: PAP-04V-S
 [JST MFG CO. LTD.]

<Connector pin layout drawing>

Connector pin No.	Terminal name
①	+V
②	Comparison output 1
③	Standard type: Comparison output 2 High function type: Analog voltage/current output or external input
④	0V

- Use an applicable cable and crimp tools for housing and contact if connected with the connector set (PPX-CN).

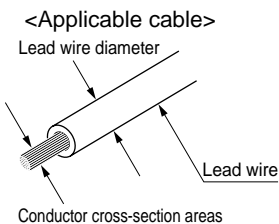

Conductor cross-section areas	0.12 to 0.32mm ² (AWG26 to 22)
Lead wire diameter	φ1.0 to φ1.5mm
Wire	Annealed copper twist wire

Housing	JST MFG CO. LTD. PAP-04V-S
Contact	JST MFG CO. LTD. SPHD-001T-P0.5
Recommended crimp tools	JST MFG CO. LTD. YC-610R (AWG26 to 24) JST MFG CO. LTD. YC-611R (AWG22)

■ Wiring

- Connect cable with power turned OFF. Discharge static electricity charged in human body, tool or equipment before and during operation.
- Use stabilized power supply with ripple voltage 10% or less without noise.

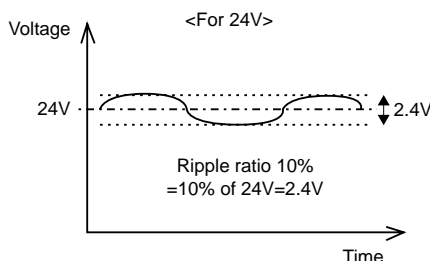

- Voltage must rise or fall quickly when power is turned ON or OFF. If the rated voltage is not reached, the sensor could malfunction. In some cases, the sensor could not recover after the rated voltage is reached. Reset the power in that case. Even if the voltage drops temporarily, shut down the power once, then turn ON the power again.
- Avoid use during the transient state (0.5s) when power turned ON.
- Install the product and wiring as far as possible from noise source such as a strong electric line, etc. Take other countermeasures for the surge from inductive loads on the power line.
- Do not operate the control unit, machinery or equipment suddenly after wiring. Due to wrong setting, signals not expected could be output. First stop control unit, machinery and equipment, while energize these to test. Set the target setting after test.
- Cable with 0.3mm² and over can be extended up to 100m. Note that the power line connected to this product must be less than 10m if used as a CE marked product.

■ Stop machinery and equipment, and check safety before setting switch output.

■ Operate the key with a fingertip. Knife, screwdriver and other hard or pointed objects may damage the plastic film over the control.

■ Do not turn off the power during or immediately after the key operation setting. It may prevent setting value from changing.

■ Piping

- Apply seal tape or sealant to screw-in joint, then screw the joint into the port to avoid excessive torque. Apply a spanner on the metal section to tighten.
- When winding seal tape, wind the tape leaving 2mm and over open from the thread top. If seal tape extrudes from the thread top, seal tape chips could be created when screwed in. These chips could enter into the circuit, and cause malfunction.

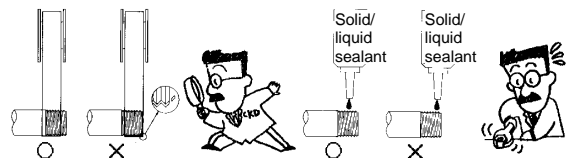

- Use pipe 1m long, and do not apply tension and impact to the pipe. If longer pipe is used, tension not expected could be created by the pipe weight, vibration or impact. In this case, use an intermediate support to fix the pipe on the machine or equipment.

■ Do not connect relays, switches or other devices to the output of this sensor in parallel at the PLC. Do not short-circuit the PLC input terminal connected to this sensor and (-) side of power to test input devices, neither, or the output circuit of this unit could be damaged.

■ When unit is changed

- If the product for domestic market is used with unit change function, and if unit other than MPa and kPa is used, put the unit label enclosed with the product on the unit display section in the control.

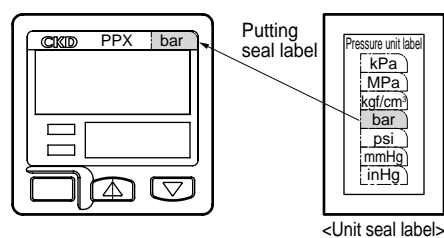

During Use & Maintenance

⚠ WARNING

■ Do not apply overcurrent.

- Due to short-circuit of load, if overcurrent applies to the pressure switch, the switch could be damaged or ignite. Install a fuse on output or power line as a overcurrent protective circuit.

⚠ CAUTION

■ Do not disassemble the product.

- Disassembling the product could result in damage or deterioration of the product. CKD will not guarantee the performance after disassembling. When replacing or moving the product, remove the sensor without disassembling pressurized port.

■ Stop machinery and equipment, then check the safety before operating the product.

■ The case is made of resin. Do not use solvent, alcohol or any other cleaning agent, etc., to remove contamination, etc., or resin could be corroded or damaged. Wipe contaminations with a well wrung rag, etc., after soaked in weakened neutral detergent.

■ Care must be taken for reverse current caused by disconnection or wiring resistance. When components including pressure switches are connected to the same power source of pressure switch, if (-) sides of output and power lines are short-circuited to check input devices of the control panel, or if (-) side of power line is disconnected, reverse current may apply to the output circuit of pressure switch, causing damages.

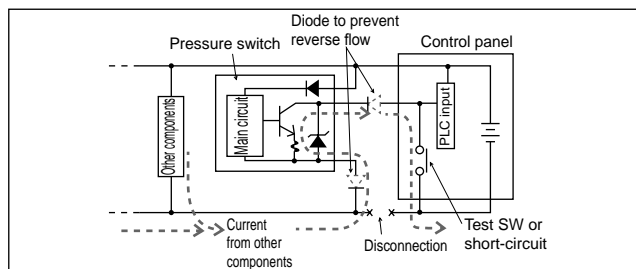

Take countermeasures as followings to prevent damages caused by reverse current.

- ① Do not concentrate current to the power line, especially, (-) side power line, and use wire as thick as possible.
- ② Limit numbers of components connected to the same power source of pressure switch.
- ③ Connect a diode in series to the pressure switch output line to prevent reverse current.
- ④ Connect a diode in series to power line (-) side of the pressure switch to prevent reverse current.

■ Care must be taken for surge current leading.

When pressure switch shares the power supply with inductive loads that create surge current such as, solenoid valves or relays, if the circuit is closed with inductive loads activated, surge current could lead to the output circuit, causing damages.

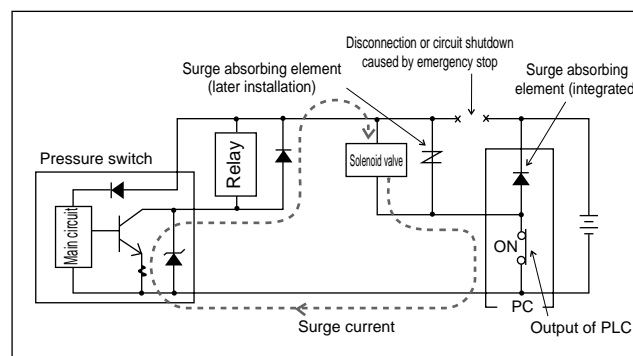

Take countermeasures as followings to prevent damage caused by surge current leading.

- ① Separate the power supply for outputs creating inductive load such as solenoid valve and relay, etc. and inputs such as pressure switch, etc.
- ② If the power cannot be separated from the inductive load, install a surge absorbing element(s) per load. The surge absorbing element(s) connected to PLC, etc. merely protects the unit connected.
- ③ Connect surge absorbing element(s) to the points as following to reduce damages when lines are disconnected.

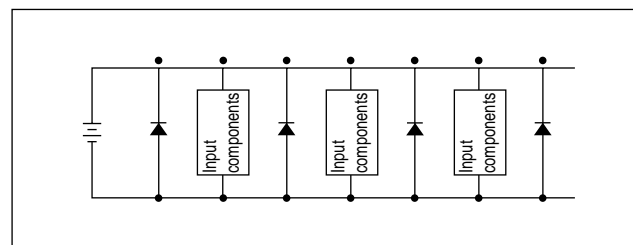

When components are connected with connectors, if a connector is dislocated during energizing, the output circuit could be damaged because of the reason above. Turn off the power before dislocating a connector.

Related products

Vacuum regulator EVR Series

- High precision pressure accuracy
 - Hysteresis: 0.3% F.S., linearity: $\pm 0.5\%$ F.S., resolution: 0.1% F.S., repeatability: 0.2% F.S.
- Improved temperature stability and durability
 - Zero point fluctuation: 0.06% F.S., span fluctuation: 0.06% F.S., durability: 3 times (compared with previous models)
- New functions are available
 - Zero residual pressure when input signal is 0% F.S. Select pressure control pattern.
- Easy operation
 - "Zero point adjustment", "span point adjustment", "pressure control pattern" can be operated with 2 buttons.
- Compatibility and installability
 - Installation compatibility with previous model (EV2500)
 - 2 types of connector are available. (straight type, L type, 1m and 3m for each type)

Catalog no. CC-1174A

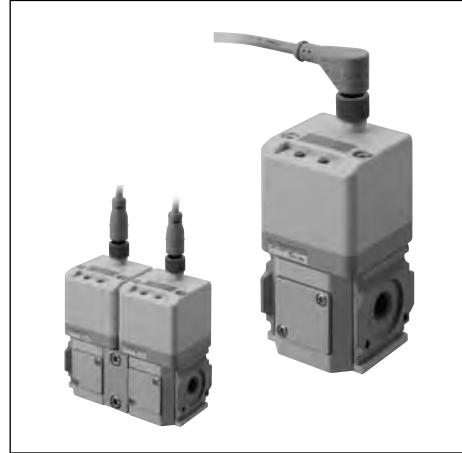

Precision regulator air saving type RPE Series

Environment conscious, new type precise regulator

- 70% less air consumption
- High precision pressure control
- Small size 42mm, light weight 250g
- Modular design
- Standard ozone-resistant materials for moving sections
- Non grease specification fluid passage

Catalog no. CC-1072A



Precision regulator RP1000, RP2000 Series

Suitable regulator for pressure control or balancer

- High precision pressure control
- Large pressure relief flow rate
- Micro pressure is configurable (RP1000)
- Small and compact
- Long service life (RP2000)

Catalog no. CB-024SA



Related products

FRL Module type

Digital pressure sensor PPX is equipped as option for FRL modular type combination, filter regulator, and regulator.

Catalog no. CB-024SA



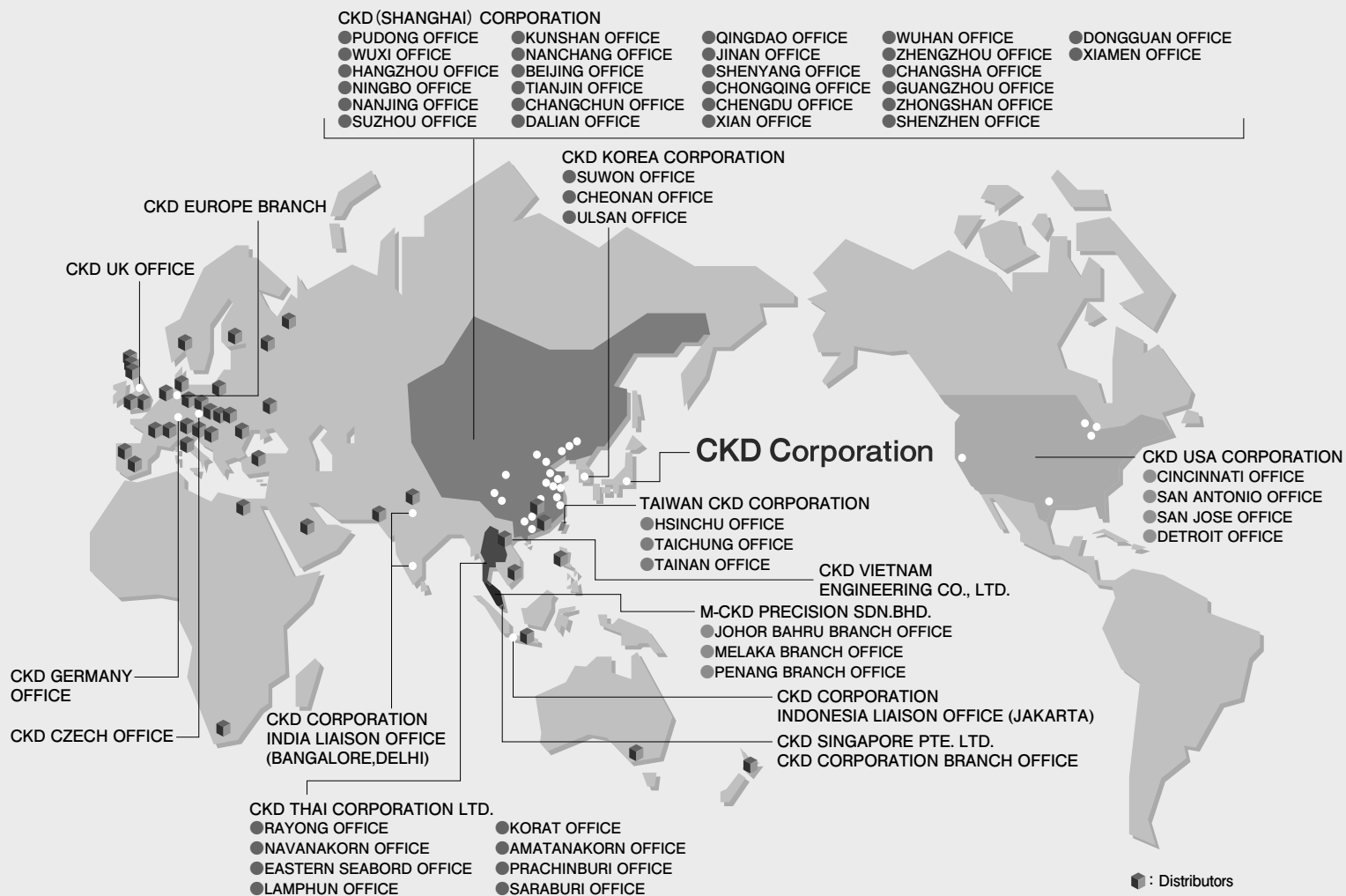

CKD Corporation

- OVERSEAS SALES ADMINISTRATION DPT. SALES AND MARKETING DIV. 2-250 Ouji Komaki, Aichi 485-8551, Japan
- PHONE +81-(0)568-74-1338 FAX +81-(0)568-77-3461

U.S.A.

CKD USA CORPORATION

- CHICAGO HEADQUARTERS
- 4080 Winnetka Avenue, Rolling Meadows, IL 60008, USA
- PHONE +1-847-368-0539 FAX +1-847-788-0575

EUROPE

CKD CORPORATION EUROPE BRANCH

De Fruittuinen 28 Hoofddorp, the Netherlands
PHONE +31-(0)23-5541490 FAX +31-(0)23-5541491

Malaysia

M-CKD PRECISION SDN.BHD.

- HEAD OFFICE
- Lot No.6, Jalan Modal 23/2, Seksyen 23, Kawasan MIEL, Fasa 8, 40300 Shah Alam, Selangor Darul Ehsan, Malaysia
- PHONE +60-(0)3-5541-1468 FAX +60-(0)3-5541-1533

Thailand

CKD THAI CORPORATION LTD.

- SALES HEADQUARTERS
- Suwan Tower, 14/1 Soi Saladaeng 1, North Sathorn Road, Kwaeng Silom, Khet Bangrak, Bangkok 10500, Thailand
- PHONE +66-(0)2-267-6300 FAX +66-(0)2-267-6305

Website <http://www.ckd.co.jp/>

Singapore
CKD SINGAPORE PTE. LTD.
No.33 Tannery Lane #04-01 Hoesteel Industrial Building, Singapore 347789, Singapore
PHONE +65-67442623 FAX +65-67442486

CKD CORPORATION BRANCH OFFICE
No.33 Tannery Lane #04-01 Hoesteel Industrial Building, Singapore 347789, Singapore
PHONE +65-67447260 FAX +65-68421022

Vietnam
CKD VIETNAM ENGINEERING CO., LTD.
18th Floor, CMC Tower, Duy Tan Street, Cau Giay District, Hanoi, Vietnam
PHONE +84-4-37957631 FAX +84-4-37957637

Taiwan
TAIWAN CKD CORPORATION
16F-3, No. 7, Sec. 3, New Taipei Blvd., Xinzhuang Dist., New Taipei City 242, Taiwan
PHONE +886-(0)2-8522-8198 FAX +886-(0)2-8522-8128

China
CKD (SHANGHAI) CORPORATION
● SALES HEADQUARTERS / SHANGHAI OFFICE
Room 601, Yuanzhongkeyan Building, No. 1905 Hongmei Road, Xinhui District, Shanghai 200233, China
PHONE +86-(0)21-61911888 FAX +86-(0)21-60905356

Korea
CKD KOREA CORPORATION
● HEADQUARTERS
(3rd Floor), 44, Sinsu-ro, Mapo-gu, Seoul 121-856, Korea
PHONE +82-(0)2-783-5201~5203 FAX +82-(0)2-783-5204

The goods and their replicas, or the technology and software in this catalog are subject to complementary export regulations by Foreign Exchange and Foreign Trade Law of Japan.
If the goods and their replicas, or the technology and software in this catalog are to be exported, laws require the exporter to make sure they will never be used for the development or the manufacture of weapons for mass destruction.